

IEC Pin and Sleeve

60A, 3 Phase, 600V, 3 Pole, 4 Wire

Reverse Service Mechanical Interlock

Features

- Reverse service plug cannot be removed under load.
- Captured neoprene gasket for a watertight seal
- Lockable handle to meet OSHA Lockout/Tagout regulations.
- Solid pins for longer life and reliable electrical contact
- Enclosure Type 4X, 12 and IP67 Suitability

Ordering Information

Description	UPC	Catalog Number
Circuit-Lock® Reverse Service Mechanical Interlock	783585012629	HBL460MI5WR

Color code

Black

Standards

UL Listed
CSA Certified

Specifications

Face	Valox®
Base	Valox®
Enclosure Gasket	Neoprene
Shaft Seal	Neoprene
Conduit Hub	Zinc

Performance

Electrical	
Current Interrupting	Certified for current interrupting at full rated current and voltage
Dielectric Voltage	Withstands 3,000V AC Min
Max. Working Voltage	600V AC RMS

Mechanical

Impact Resistance	In accordance with UL 746C
Mounting	External adjustable feet
Product Identification	Identification and ratings are part of the external label and molded into the receptacle mount
Terminal Identification	In accordance with UL, CSA and international conventions

Environmental

Flammability	UL94-5VA and V-0 Classification
Ingress Protection	IP67 Suitability
Moisture Resistance	Outdoor - 4X (Watertight, Washdown); Indoor - 12 (Dust-tight, Falling Dirt and Noncorrosive Liquids).
Operating Temperature	Max. Continuous +75°C; Min. Continuous -40°C

Online Resources

Customer Use Drawing
eCatalog
Installation Instructions

HUBBELL

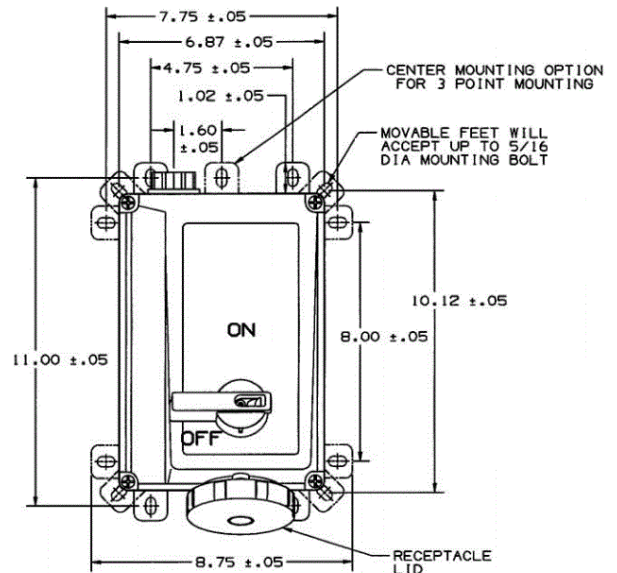

Dimensions in Inches (mm)

Hubbell Wiring Device-Kellems • Hubbell Incorporated (Delaware) • 40 Waterview Drive • Shelton, CT 06484

Phone (800) 288-6000 • Fax (800) 255-1031 • Specifications subject to change without notice.

