

IEC Pin and Sleeve

30/32A, 200-415V, 4 Pole, 5 Wire

Watertight Inlet

Features

- UL Type 4X, 12 and IP69k environmental ratings
- Impact and corrosion resistant insulated non-metallic housing
- Solid one-piece pins for reliable electrical contact
- Gasketed sealing ring provides watertight seal
- Sequential contact engagement to prevent a momentary over-voltage

Ordering Information

Description	UPC	Catalog Number
Watertight IEC Pin and Sleeve Inlet	783585574578	HBL530B6W

Listings

UL Listed, File E146032
CSA Certified File LR280C
UL Classified to IEC 60309-1
IEC 60309-2

Specifications

Housing	PBT
Locking Ring	PBT
Sealing Gasket	Solid Neoprene
Retainer	High-Impact Thermoset
Terminal Screws	Stainless Steel
Contact Carrier	High-Impact Thermoset

Performance

Electrical	
Current Interrupting	Certified for current interrupting at full rated current
Dielectric Voltage	Withstands 3,000V AC
Max. Working Voltage	600V AC RMS

Mechanical	
Impact Resistance	Per CSA C22.2 No. 182.1 / UL1682
Product Identification	Identification and ratings are a permanent part of the device housing.
Terminal Identification	Terminals identified in accordance with North American and IEC conventions

Environmental	
Flammability	V-0
Ingress Protection	Type 3R,3RX,4X and IP68,IP69K
Moisture Resistance	IEC 60309-1
Operating Temperature	Maximum Continuous 75°C; Minimum - 40°C w/o impact

Complementary Products

Closure Cap
Locking Ring

HUBBELL

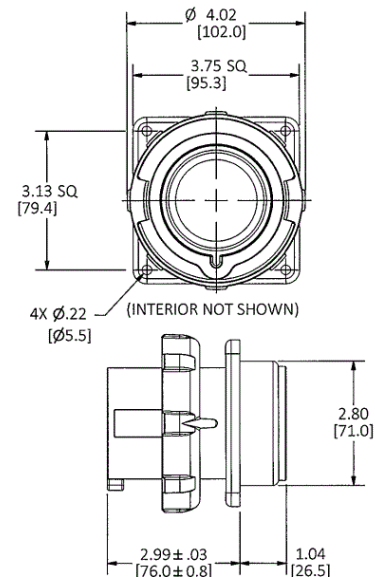

Dimensions in Inches (mm)

Hubbell Wiring Device-Kellems • Hubbell Incorporated (Delaware) • 40 Waterview Drive • Shelton, CT 06484

Phone (800) 288-6000 • Fax (800) 255-1031 • Specifications subject to change without notice.

