

## IEC Pin and Sleeve

60A, 3 PhaseY, 120/208V, 4 Pole, 5 Wire

## Watertight Plug

### Features

- UL Type 4X, 12 and IP69k environmental ratings
- One piece non-metallic housing provides impact and chemical resistance in an insulated body
- Watertight neoprene gland seal to prevent water ingress from entering at cable entrance
- Solid one-piece pins for reliable electrical contact
- Sequential contact engagement to prevent a momentary over-voltage

### Ordering Information

Description	UPC	Catalog Number
Watertight IEC Pin and Sleeve Mating Plug	783585405704	HBL560P9W

### Listings

UL Listed, File E146033  
CSA Certified File LR280C  
Listed to standard UL1682

### Specifications

Housing	PBT
Locking Ring	PBT
Sealing Gasket	Solid Neoprene
Contact Carrier	High-Impact Thermoset
Glands	Santoprene
Terminal Screws	Stainless Steel
Cord Clamps	PBT

### Performance

Electrical	
Current Interrupting	Certified for current interrupting at full rated current
Dielectric Voltage Max. Working Voltage	Withstands 3,000V AC 600V AC RMS
Mechanical	
Impact Resistance	Per CSA C22.2 No.182.1 /UL1682
Product Identification	Identification and ratings are a permanent part of the device housing
Terminal Identification	Terminals identified in accordance with North American and IEC conventions
Environmental	
Flammability	V-0
Ingress Protection	Type 3R,3RX,4X and IP68,IP69K
Moisture Resistance	IEC 60309-1
Operating Temperature	Maximum Continuous 75°C; Minimum - 40°C w/o impact

### Complementary Products

Closure Cap  
Cord Clamp and Locking Ring  
Liquidtight Adapters

# HUBBELL

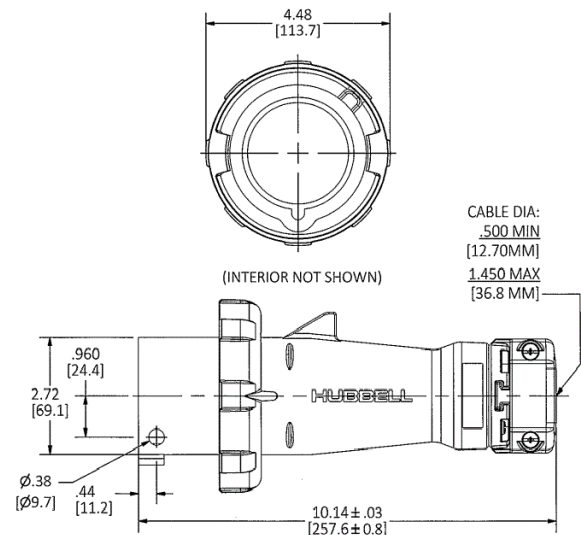

Dimensions in Inches (mm)

Hubbell Wiring Device-Kellems • Hubbell Incorporated (Delaware) • 40 Waterview Drive • Shelton, CT 06484

Phone (800) 288-6000 • Fax (800) 255-1031 • Specifications subject to change without notice.

