

Raceway
Metal Raceway

HBL4750 Series Replacement Blade Cutter
and Die Set

HUBBELL

Features

- Replacement Blade for HBL640B
- Base cutting blade only

Ordering Information

Description	Material	UPC Number	Catalog Number
Replacement Blade Cutter and Die Set	Stainless Steel	783585217499	HBL640BDK

Listings

UL Listed
CSA Certified

Specifications

Height	0.5"
Width	2.00"
Length	0.1"

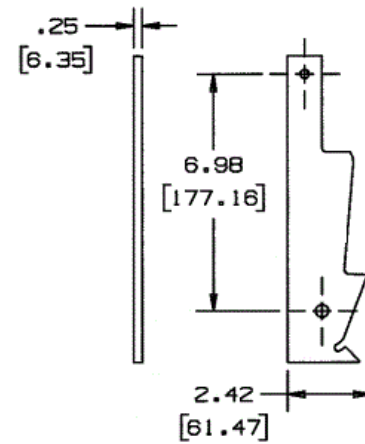

Online Resources

Customer Use Drawing
eCatalog
Installation Instructions

Dimensions in Inches (mm)

Hubbell Wiring Device-Kellems • Hubbell Incorporated (Delaware) • 40 Waterview Drive • Shelton, CT 06484

Phone (800) 288-6000 • Fax (800) 255-1031 • Specifications subject to change without notice.

