

Twist-Lock® Devices  
 50A, 250V DC, 600V AC, 3 Pole, 4 Wire  
 Grounding  
 Insulgrip® Connector

# HUBBELL

## Features

- Box terminal with hex socket threaded slug, permits high clamping pressure on conductors without damaging strands
- Heavy duty two-piece external cord clamp provides maximum strain relief
- Box terminal with hex socket threaded slug, permits high clamping pressure on conductors without damaging strands
- Thermoplastic polyester interior provides heat resistance and impact strength
- Oversized contacts minimize operating temperature

## Ordering Information

Description	Cord Diameter	UPC	Catalog Number
Nylon cover, thermoplastic polyester interior	.830"-1.250" (21.08-31.75)	783585237848	HBL7764C

## Listings

Listed to UL 498  
 Certified to CSA C22.2 No.42

## Specifications

Housing	Nylon
Terminal Retainer	Thermoplastic polyester
Contacts	Brass
Terminal Screws	Stainless Steel
Cord Grip	Polyester

## Performance

### Electrical

Current Interrupting	Certified for current interrupting at full rated current
Dielectric Voltage	Withstands 2,000V minimum

### Mechanical

Terminal Accommodation	#10 AWG - #6 AWG stranded copper wire only
------------------------	--

### Environmental

Flammability	HB or better
Operating Temperatures	Maximum continuous 75°C; minimum -40°C (w/o impact)

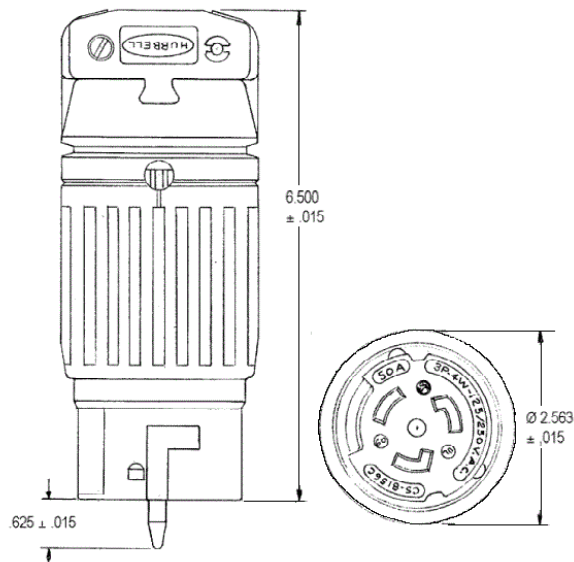

## Accessories

Plug	HBL7765C
Weatherproof Boot	HBL7717C
Flanged Inlet	HBL7958
Weatherproof Boot	HBL7716C

## Resources

Customer Use Drawing  
 eCatalog

Dimensions in Inches (mm)

Hubbell Wiring Device-Kellems • Hubbell Incorporated (Delaware) • 40 Waterview Drive • Shelton, CT 06484

Phone (800) 288-6000 • Fax (800) 255-1031 • Specifications subject to change without notice.

