

Wire Management Products

Cord and Cable Reels

Industrial Power Cord Reels

HUBBELL

Features

- Durable, Corrosion Resistant Cast Aluminum Construction
- UL Type 1
- Multi-Position Guide Arm can be mounted in two different positions
- Positive Latch mechanism automatically maintains desired cord length
- Ratchet Lock can be disengaged in field for constant tension applications

Ordering Information

Description
Yellow Industrial Reel with Black Box and (1) 20A Duplex Receptacle, UL Type 1, 45 Ft., #12/3 SJO, 20 A, 125 VAC

UPC Number 783585585055
Catalog Number HBLI45123R20M1Y



Listings

cULus Listed

Specifications

Spool	Aluminum
Guide Frame	Thermoplastic
Cord	Copper
Internal Terminals	Copper Alloy
Ball Stopper	Thermoplastic
Fitting	Aluminum

Performance

Amperage

20 A

Max. Working Voltage

125V AC

Moisture Resistance

Dry, Indoor, Non-Hazardous Locations - UL Type 1

Number of Wires

3-Wire

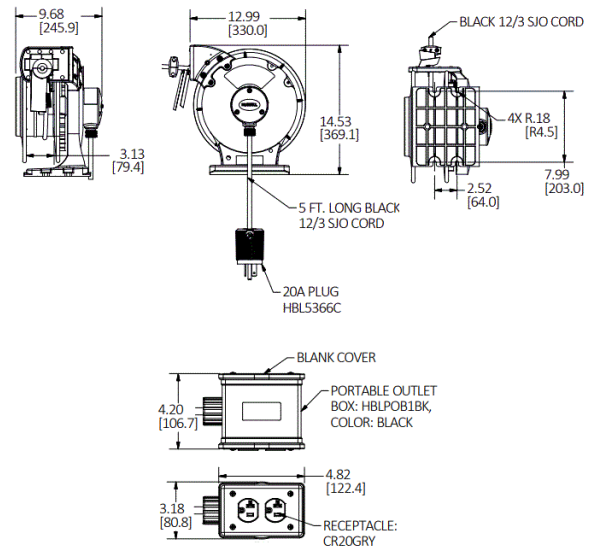

Related Products

Pivot Base	HBLI340PB
Mounting Bracket	HBLIMB
Ball Stop	HBLI12BS

Online Resources

Customer Drawing
Customer Sales Drawings
eCatalog
Installation/Instruction Manual

Dimensions in Inches (mm)

Hubbell Wiring Device-Kellems • Hubbell Incorporated (Delaware) • 40 Waterview Drive • Shelton, CT 06484

Phone (800) 288-6000 • Fax (800) 255-1031 • Specifications subject to change without notice.

