

## Wire Management Products

### Cord and Cable Reels

## Weatherproof Cord Reels

### Features

- Durable, Corrosion Resistant Cast Aluminum Construction
- UL Type 4
- Multi-Position Guide Arm can be mounted in two different positions
- Positive Latch mechanism automatically maintains desired cord length
- Ratchet Lock can be disengaged in field for constant tension applications

### Ordering Information

Description	UPC Number	Catalog Number
White Weatherproof Reel, UL Type 4, 25 Ft, #10/4 SOW, 30 A, 600 VAC	783585586151	HBLW25104W

### Listings

cULus Listed

### Specifications

Spool	Aluminum
Guide Frame	Thermoplastic
Cord	Copper
Internal Terminals	Copper Alloy
Ball Stopper	Thermoplastic
Fitting	Aluminum

### Performance

#### Amperage

30 A

#### Max. Working Voltage

600V AC

#### Moisture Resistance

Dry, Indoor and Wet and Damp Outdoor, Non-Hazardous Locations - UL Type 4

#### Number of Wires

4-Wire

# HUBBELL

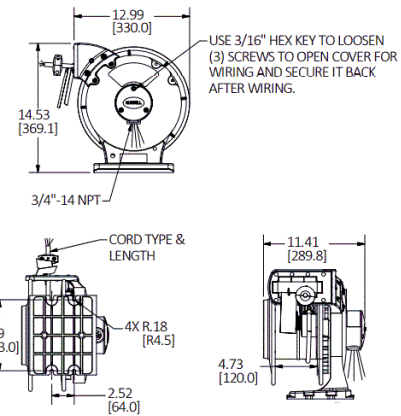

### Related Products

Pivot Base	HBLI340PB
Mounting Bracket	HBLIMB
Ball Stop	HBLI10BS

### Online Resources

Customer Drawing  
Customer Sales Drawings  
eCatalog  
Installation/Instruction Manual

Dimensions in Inches (mm)

Hubbell Wiring Device-Kellems • Hubbell Incorporated (Delaware) • 40 Waterview Drive • Shelton, CT 06484

Phone (800) 288-6000 • Fax (800) 255-1031 • Specifications subject to change without notice.

