

Straight Blade Devices
 15A, 125V, 2 Pole, 3 Wire Grounding
 Commercial Specification Grade Decorator
 Duplex Receptacles

HUBBELL

Features

- Triangle marking on face indicates isolated ground
- Aesthetic Style Line® decorator design
- Triple wipe contacts

Ordering Information

Description	Device Color	UPC	Catalog Number
Isolated ground, Style Line® decorator, smooth face	Light Almond	783585147857	IG15DRLA

Listings

UL Listed to UL498 File No. E2186
 Certified to CSA C22.2, No. 42
 Fed. Spec. WC596
 NEMA® WD-6 Compliant

Specifications

Face	Nylon
Base	Nylon
Power Contact	.030" (.8) Brass
Ground Contacts	Brass
Terminal Clamp	.062" (1.6) Nickel Plated steel
Terminal Screws	Plated steel
Mounting Strap	.040 in. (1) Galvanized steel
Automatic Self-grounding Staple	Stainless steel
Mounting Screws	Galvanized Steel

Performance

Electrical

Current Interrupting	Certified for current interrupting at full rated current
Dielectric Voltage	Withstands 2,000V minimum

Mechanical

Product Identification	Ratings are a permanent part of the device
Terminal Accommodation	#14-#10 AWG copper stranded or solid conductor only
Terminal Identification	Terminals identified in accordance with UL 498 and CSA

Environmental

Flammability	UL 94 V-2
Operating Temperatures	Maximum continuous 75°C; minimum -40°C (w/o impact)

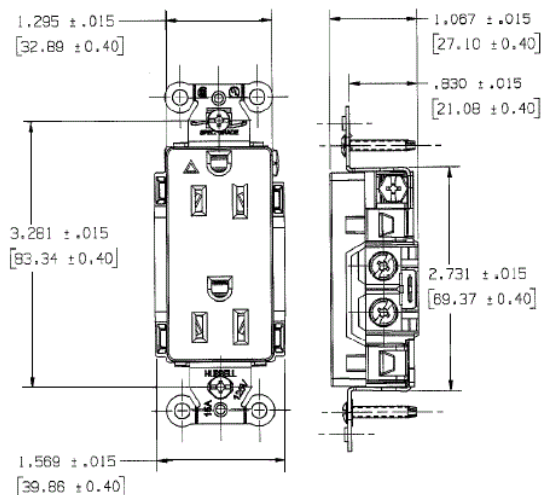

Accessories

Wallplate or Weatherproof Cover StyleLine® Decorator Opening

Resources

Customer Use Drawing
 eCatalog

Dimensions in Inches (mm)

Hubbell Wiring Device-Kellems • Hubbell Incorporated (Delaware) • 40 Waterview Drive • Shelton, CT 06484

Phone (800) 288-6000 • Fax (800) 255-1031 • Specifications subject to change without notice.

