

Twist-Lock® Devices
15A, 250V, 2 Pole, 3 Wire Grounding
Isolated Ground Receptacle

HUBBELL

Features

- Reinforced thermoplastic construction
- Single piece, all brass contacts
- All terminals are back and side wired
- Brass mounting strap with stainless steel grounding clip



Ordering Information

Description	Device Color	UPC	Catalog Number
Single, isolated	Orange	783585777993	IG4560

Listings

Listed to UL 498
 Fed. Spec. W-C-596
 Certified to CSA C22.2 No.42

Specifications

Face	Nylon
Base	RTP
Contacts	Brass
Clamp	Brass
Ground Contact	Brass
Terminal Screws	Brass

Performance

Electrical	
Current Interrupting	Certified for current interrupting at full rated current
Dielectric Voltage	Withstands 2,000V minimum
Mechanical	
Terminal Accommodation	#18 AWG - #10 AWG solid or stranded copper wire.
Terminal Identification	Terminals identified in accordance with UL 498
Environmental	
Flammability	HB or better per UL94/CSA 22.2 No.0.17
Moisture Resistance	IP20 Suitability
Operating Temperatures	Maximum Continuous 75°C; Minimum -40°C (w/o impact)

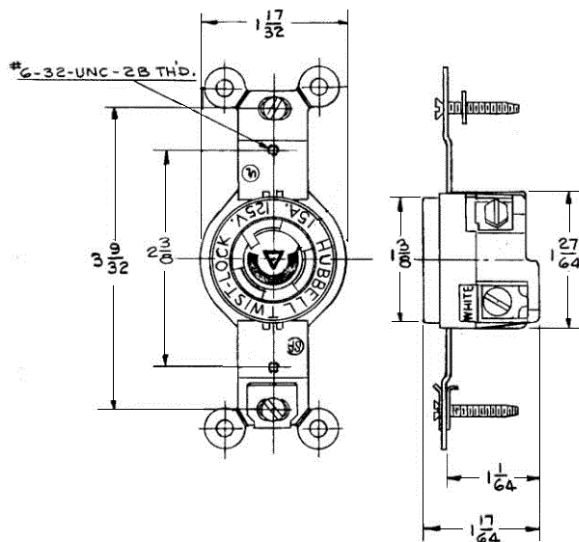

Online Resources

- Customer Use Drawing
- eCatalog
- Installation Instructions

Accessories

Plug	HBL4570C
Wallplate or Weatherproof Cover	1.40" Opening

Dimensions in Inches (mm)

Hubbell Wiring Device-Kellems • Hubbell Incorporated (Delaware) • 40 Waterview Drive • Shelton, CT 06484

Phone (800) 288-6000 • Fax (800) 255-1031 • Specifications subject to change without notice.

