

Raceway
Non-Metallic Raceway
PB2 BaseTrak® Base

HUBBELL

Features

- Two channel raceway
- Available in 5 ft. (1.5m) and 10 ft. (3m) lengths.
- Available in Pre-Wired Raceway

Ordering Information

Description	Color	UPC Number	Catalog Number
Base	Office White	783585310015	PB2B5



Listings

UL Listed
CSA Certified

Specifications

Height	1.42"
Width	4.50"
Length	5'

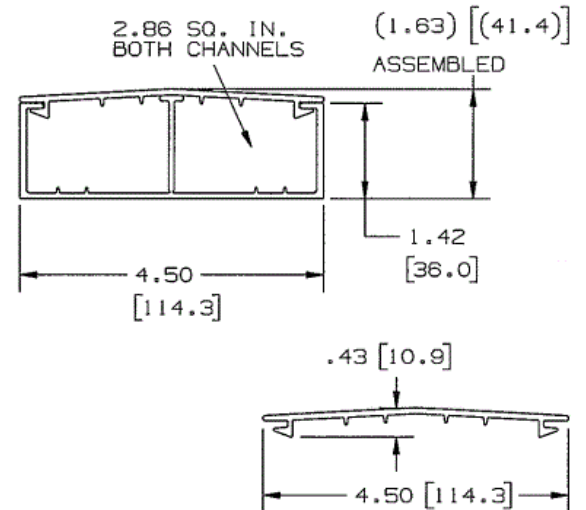

Online Resources

Customer Use Drawing
eCatalog
Installation Instructions

Dimensions in Inches (mm)

Hubbell Wiring Device-Kellems • Hubbell Incorporated (Delaware) • 40 Waterview Drive • Shelton, CT 06484

Phone (800) 288-6000 • Fax (800) 255-1031 • Specifications subject to change without notice.

