

Wallplates
 While-In-Use Weatherproof Covers
 For Maximum In-Use Protection

HUBBELL

Ordering Information

Description	Color	Catalog Number	UPC
2-gang, duplex, GFCI, toggle and single receptacle, vertical mounting	Gray	RW57900	883778119590



Listings

UL Listed - Canadian and U.S.

Specifications

Material	Thermoplastic
Gasket	Foam
Screws	Steel

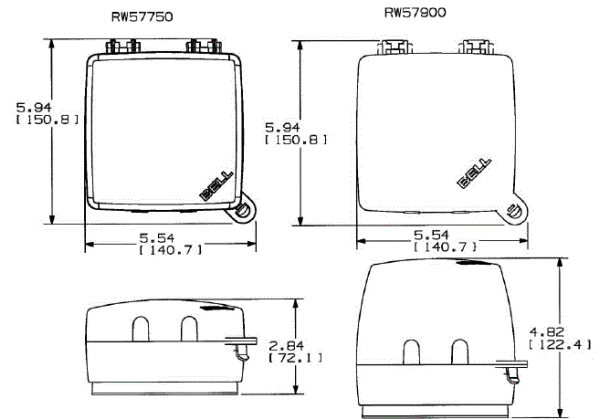

Online Resources

Customer Use Drawing
 eCatalog

Dimensions in Inches (mm)

Hubbell Wiring Device-Kellems • Hubbell Incorporated (Delaware) • 40 Waterview Drive • Shelton, CT 06484

Phone (800) 288-6000 • Fax (800) 255-1031 • Specifications subject to change without notice.

