

Fire-Rated Poke-Throughs
SystemOne Recessed
Sub-Plate

HUBBELL

Features

- 4 marked with I/O
- Used with automatic receptacle control systems
- White Powder Coated

Ordering Information

- Includes necessary mounting hardware

Catalog Number	UPC	Description
S1R6SPHC4	783585545547	Sub-plate for 6 inch FRPT 50% , right side, with four pre-wired 20A receptacle cubes

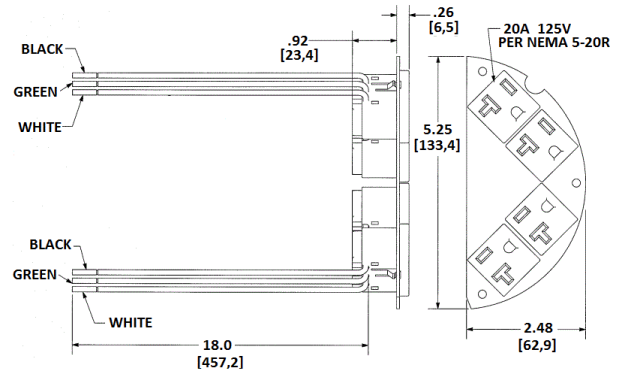

Standards

cULus Listed

Online Resources

eCatalog

Dimensions in Inches (mm)

Hubbell Wiring Device-Kellems • Hubbell Incorporated (Delaware) • 40 Waterview Drive • Shelton, CT 06484

Phone (800) 288-6000 • Fax (800) 255-1031 • Specifications subject to change without notice.

