

Straight Blade Devices

20A, 125V, 2 Pole, 3 Wire Grounding

Extra Heavy Duty SNAPconnect® Single Receptacle

HUBBELL

Features

- Audible SNAP indicates solid connection
- Reduces installation time
- Fully insulated design
- Tamper Resistant

Ordering Information

Description	Device Color	UPC Number	Catalog Number
Specification grade, smooth nylon face	Gray	783585557472	SNAP5361GYTR



Listings

UL Listed to UL498 File No. E2186
Certified to CSA, C22.2, No. 42 File 285
Fed. Spec. W-C-596
NEMA® WD-6 Compliant

Specifications

Face	Nylon
Base	Nylon
Power Contacts	Brass
Ground Contacts	Brass
Mounting Strap	Galvanized steel
Automatic Self-grounding Staple	Stainless steel
Mounting Screws	Zinc plated steel

Performance

Electrical	
Current Interrupting	Certified for current interrupting at full rated current
Dielectric Voltage	Withstands 2,000V minimum
Mechanical	
Product Identification	Ratings are a permanent part of the device
Environmental	
Flammability	UL 94V-2
Operating Temperature	Maximum continuous 75°C; minimum -40°C (w/o impact)

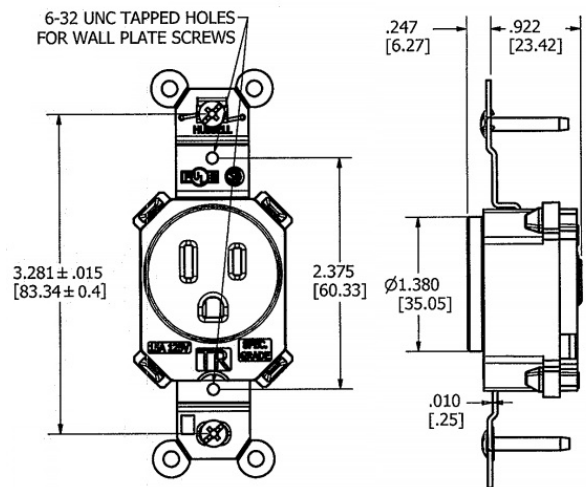

Complementary Products

Stranded SNAPconnector	SNAP2RA
Solid SNAPconnector	SNAP1RA

Online Resources

Customer Use Drawing
eCatalog
Installation Instructions

Dimensions in Inches (mm)

Hubbell Wiring Device-Kellems • Hubbell Incorporated (Delaware) • 40 Waterview Drive • Shelton, CT 06484

Phone (800) 288-6000 • Fax (800) 255-1031 • Specifications subject to change without notice.

