



WMA38

1. ARM

2. COLOR

## 1. ARM

WMA38 (Weight: 12 lbs.)

## 2. COLOR

- BLS** Black Gloss Smooth
- BLT** Black Matte Textured
- DBS** Dark Bronze Gloss Smooth
- DBT** Dark Bronze Matte Textured
- GTT** Graphite Matte Textured
- LGS** Light Grey Gloss Smooth
- LGT** Light Grey Matte Textured
- PSS** Platinum Silver Smooth
- VGT** Verde Green Textured
- WHS** White Gloss Smooth
- WHT** White Matte Textured

### Color Option

**CC\*** Custom Color

*\* Consult factory for custom color, marine and corrosive finish options*

## DIMENSIONS

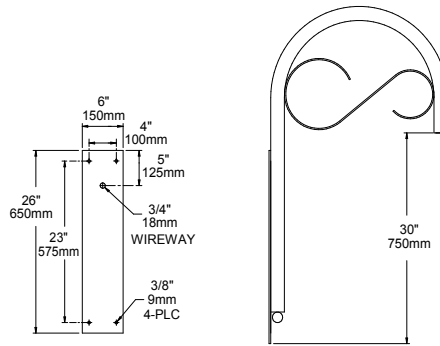

Note: Back plate is welded to the arm.

WMA38

## SPECIFICATIONS

The arm shall be of one piece unitized aluminum construction, fully welded and assembled. The back plate shall be one piece cast aluminum. The arm shall be prewired with a quick connector for easy installation.

The arm shall have a cast aluminum fitter welded to the top of the arm(s) for attaching the fixture. The fixture shall be mounted with three stainless steel bolts through the top of the arm fitter into the fixture. The attachment point shall have a silicone pad for sealing the fixture to arm connection.

Mounting hardware and J-box by others.

JOB \_\_\_\_\_  
 TYPE \_\_\_\_\_  
 NOTES \_\_\_\_\_  
 \_\_\_\_\_