

# COBRA BALBOA

COBRA ARM

## SPECIFICATIONS

### CONSTRUCTION

- All cast aluminum parts shall be low copper alloy A356. All extruded aluminum parts shall be alloy 6061-T6. 6063-T5 or equal
- End of arm  $2 \frac{3}{8} \varnothing$
- All fasteners shall be Corrosion Resistant. When tamper resistant fasteners are required, spanner HD (snake eye) style shall be provided (special tool required, available at additional cost)

### FINISH

- Durable thermoset polyester powder coat paint finish with nominal 3.0 mil thickness
- Powder paint finish coat available in twelve standard color; Custom colors available; RAL number preferable

### WARRANTY

- 5 year warranty
- See [HLI Standard Warranty](#) for additional information



### RELATED PRODUCTS

$\varnothing$  [AA-10](#)     $\varnothing$  [AA-10S](#)

## ORDERING GUIDE





Example: AA-10B-S-4-B-S-BBT

CATALOG #

Model	Post Shaft Profile	Post Shaft Diameter	Arrangement	S Luminaire Mounting	Color
AA-10B    Cobra Balboa	W    Wall mount S    Smooth F    Fluted	4    4" 5    5" 6    6"	A    Wall Mount B    Single Mount C    Twin Mount	S    Slide	DB    Dark Bronze Textured BL    Black Matte Textured PS    Platinum Silver WH    White Textured GYS    Gray Smooth BZT    Bronze Textured BBT    Basic Black Textured RAL    _____

## EPA INDEX INFORMATION

AA-10B Arrangement (EPA index ft<sup>2</sup>)

				
Size	A	B	C	F
4	–	3.38	4.65	6.30
5	–	3.45	4.72	6.37
6	–	3.52	4.79	6.44
Wall	2.08	–	–	–

# COBRA BALBOA

COBRA ARM

## DIMENSIONS

### Wall Plate

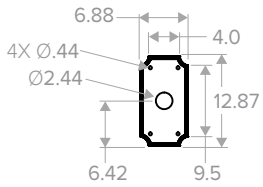

### Wall Bracket

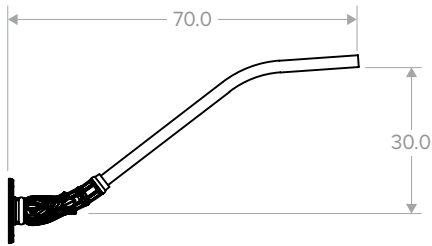

### Single Arm Mount

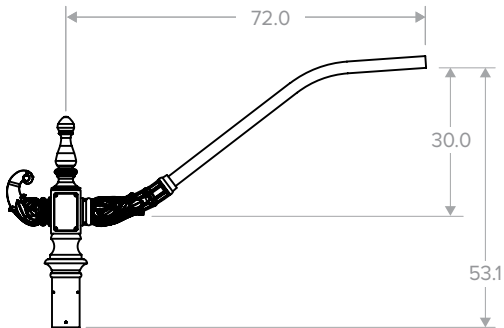

### Twin Arm Mount

