

ETA2

ARCHITECTURAL AREA/SITE

FEATURES

- TIR Strike Optics
- Patented low profile luminaire
- Available in Monochromatic Amber, 2700K, 3000K, 3500K, 4000K and 5000K
- Type 1, 2, 3, 4, 4W, 5W, 5QM, L, and R distributions
- 0 - 10V dimming drivers standard
- IP65 optical assembly



CONTROL TECHNOLOGY



SPECIFICATIONS

CONSTRUCTION

- One piece die-cast housing, low copper (<0.6% Cu) Aluminum Alloy with integral cooling ribs over the optical chamber and electrical compartment
- Solid barrier wall separates optical and electrical compartments
- Double-thick wall with gussets on the support-arm mounting end
- Housing forms a half cylinder with 55° front face plane providing a recess to allow a flush single-latch detail
- All hardware is stainless steel or electro-zinc plated steel
- Finish: fade and abrasion resistant, electrostatically applied, thermally cured, triglycidal isocyanurate (TGIC) polyester powdercoat
- One-piece die-cast, low copper (<0.6% Cu) aluminum alloy lens frame with 1" minimum depth around the gasket flange
- Optional clear 1/8" thick tempered glass lens retained by eight steel clips with full silicone gasketing around the perimete
- Optional, fixture supplied with a one-piece flat, clear, UV stabilized polycarbonate, fully gasketed, replacing the standard tempered glass lens. CAUTION: Use only when vandalism is anticipated to be high. Useful life is limited by UV discoloration from sunlight. A program of regular inspection and periodic replacement is highly recommended to maintain optimum fixture performance
- One-piece extruded aluminum arm with internal bolt guides and fully radiussed top and bottom
- Luminaire-to-pole attachment is by internal draw bolts, and includes a pole reinforcing plate with wire strain relief

CONSTRUCTION (CONTINUED)

- Arm is circular cut for specified round pole
- Optional cast, low copper aluminum horizontal slip-fitter with adaptor plate to secure the luminaire to 2" IPS pipe size arms
- Optional cast aluminum wall mount plate assembly. Attaches to the wall over the junction box. Luminaire attaches to the wall plate

OPTICS

- Optical cartridge system consisting of a die cast heat sink, LED Total Internal Reflection (TIR) optics, gasket and bezel plate
- Molded silicone gasket ensures a weather-proof seal around each individual LED
- Features revolutionary individual LED optical control based on high performance TIR optical designs
- Optional BackLight Control for complete control of unwanted backlight
- IP65 Optical assembly
- Type 1, 2, 3, 4, 4W, 5W, 5QM, R, and L standard distributions
- Available in Monochromatic Amber, 2700K, 3000K, 3500K, 4000K and 5000K
- Die-cast, low copper aluminum heat sink modules provide thermal transfer at PCB level
- Anodized aluminum heat sink modules

INSTALLATION

- Fixtures must be grounded in accordance with national, state and/or local electrical codes. Failure to do so may result in serious personal injury

Entablature®



RELATED PRODUCTS

[Ouro](#)

[Pavilion](#)

[PGL8](#)

ELECTRICAL

- Dimming range from 10% to 100% through the use of standard 0-10V interface on the programmable driver
- Modular wiring harness in the service area provides user access to the dimming circuitry
- Optional factory programmed dimming profile
- Surge protection: 10kV surge suppression
- SF for 120, 277, 347 Line volts
DF for 208, 240, 480 Line volts

CONTROLS

- 7-pin Receptacle and Button Photocell

CERTIFICATIONS AND LISTINGS

- Listed to UL1598 and CSA C22.2#250.0-24 for wet location and 40°C ambient temperatures
- IDA approved, 3000K and warmer CCTs only
- RoHS compliant
- This product qualifies as a "designated country construction material" per FAR 52.225-11 Buy American-Construction Materials under Trade Agreements effective 6/06/2020. [See Buy American Solutions](#)

WARRANTY

- 5 year warranty
- See [HLI Standard Warranty](#) for additional information

KEY DATA	
Lumen Range	4,363–20,433
Wattage Range	88.7–178.2
Efficacy Range (LPW)	46.2–128.3
Reported Life (Hours)	L70/60,000
Weight	45 lbs 20.4 kg
EPA Side View	1.8

ETA2

ARCHITECTURAL AREA/SITE

ORDERING GUIDE

Example: 1A-ETA2-54L-750-35K8-3-CLR-SQ-UNV-BLT-7PR-SF-A4

CATALOG #

Mounting		Model	LED Engine	CCT/CRI ⁶		Distribution	Lens Options	House Side Shield
1A	Single Arm Mount	ETA2 Entablature 2.0 Large Fixture	54L-560 54 LEDs - 11,000 Lumens	AM ¹ Monochromatic Amber ¹	1 Type I	(Blank) No Lens CLR Clear Glass Lens CP Clear Polycarbonate Lens	BC ⁷ Backlight Control	
1W	Wall Mount		54L-750 54 LEDs - 14,000 Lumens	27K8 ² 2700K, 80CRI	2 Type II			
HSF	Horizontal Slipfitter		81L-700 81 LEDs - 19,000 Lumens	27K9 ² 2700K, 90CRI	3 Type III			
				3K7 3000K, 70CRI	4 Type IV Forward			
				3K8 ² 3000K, 80CRI	4W Type IV Wide			
				3K9 ² 3000K, 90CRI	5W Type V Wide			
				35K8 ² 3500K, 80CRI	5QM Type V Square Medium			
				35K9 ² 3500K, 90CRI	R Corner Right			
				4K7 4000K, 70CRI	L Corner Left			
				4K8 ² 4000K, 80CRI				
				4K9 ² 4000K, 90CRI				
				5K7 5000K, 70CRI				
				5K8 ² 5000K, 80CRI				
				5K9 ² 5000K, 90CRI				

Mounting Options	Voltage	Fixture Finish	Photocell Options	Fuse Options	Optional Entablatures
VSF ⁸ Vertical Slipfitter Mount for 2" pipe tenon (2-3/8" O.D. x 4" LONG)	UNV 120-277V	BLS Black Gloss Smooth	7PR 7-Pin Photocell Receptacle	SF Single Fuse 120, 277, 347 Line Volts	A1 Arch
SVSF ⁸ Vertical Slipfitter Mount square for 2" pipe tenon (2-3/8" O.D. x 4" LONG)	347 347V	BLT Black Matte Textured	PC Button Photocell	DF Double Fuse 208, 240, 480 Line Volts	A2 Broken Arch
3 Side Arm Mount 3" O.D. Pole	480 480V	DBS Dark Bronze Gloss Smooth			A3 Stepped Arch
3.5 Side Arm Mount 3.5" O.D. Pole		DBT Dark Bronze Matte Textured			A4 Stepped Brock Arch
4 Side Arm Mount 4" O.D. Pole		GTT Graphite Matte Textured			A5 Standard Entablature
5 Side Arm Mount 5" O.D. Pole		LGS Light Grey Gloss Smooth			P6 Peak
6 Side Arm Mount 6" O.D. Pole		LGT Light Grey Matte Textured			P7 Broken Peak
SQ Side Arm Mount Square Pole		PSS Platinum Silver Smooth			P8 Stepped Peak
		VGT Verde Green Matte Textured			P9 Stepped Broken Peak
		WHS White Gloss Smooth			P10 Stepped
		WHT White Matte Textured			See Page 5 for details
		Color Option			
		CC Custom Color			

Control Options	Control Accessories ³
SCH-R Round Pole Mounted (Occupancy Sensor up to 30')	SW7PR ⁴ SiteSync with 7 pin PCR
	SWUSB SiteSync Software on USB
SCH-S Square Pole Mounted (Occupancy Sensor up to 30')	SWTAB ⁵ SiteSync Windows Tablet
	SWBRG SiteSync Wireless Bridge Node
	WIR-RME-L wiSCAPE 7-pin Module
	NXOFM-1R1D-UNV NX 7-pin Module

Notes:

- 1 Turtle Friendly.
- 2 See Lumen Multiplier chart on [Page 13](#) for lumen scaling factor. Consult factory for additional details.
- 3 Not available with other sensor or wireless control options
- 4 Specify group and zone at time of order. See www.hubbellighting.com/sitesync for more details. Order at least one SiteSync interface accessory SWUSB or SWTAB. Each option contains SiteSync License, GUI, and Bridge Node
- 5 Microsoft, Encarta, MSN, and Windows are either registered trademarks or trademarks of Microsoft Corporation in the United States and/or other countries
- 6 5-step MacAdam Ellipse Binning is standard. Consult factory for 3-step MacAdam Ellipse Binning
- 7 Not available with 5QM and 5W distributions
- 8 For all arm configurations, please refer to [page 4](#). VSF/SVSF options ordered separately.

ETA2

ARCHITECTURAL AREA/SITE

SPECIFICATIONS (CONTINUED)

CONTROLS

BUTTON PHOTOCELL

- Factory installed photocell inside housing with a fully gasketed sensor on the side wall. For multiple fixture mountings, one fixture is supplied with a photocell to operate the others

7PR

- Fully gasketed and wired 7-pin receptacle option. Easy access location above the electrical compartment. 7-pin construction allows for a user-defined interface and provides a controlled definition of operational performance. ANSI twist-lock control module by-others
- Standard customer operation modes:
 1. Traditional on/off photoelectric control
 2. 5-pin wireless photoelectric control for added dimming feature
 3. 7-pin wireless photoelectric control for dimming and additional I/O connections for customer use

Photocell receptacle wiring diagram

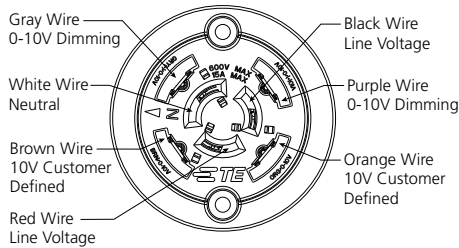

wiSCAPE™

- Hubbell Control Solution's wiSCAPE™ wireless control modules allow an individual fixture to be managed, monitored and measured. The modules communicate securely over a robust certified meshed radio signal. The wiSCAPE modules provide on/off/dim control, external device input, alerts and metering.

WIR-RME-L

- wiSCAPE External Module, 120-480V, 1000ft range (LOS), Internal Photocell, 1 Digital Input, Compatible with the A-25-7H option

SITESYNC™1

- SiteSync™ wireless control system for reduction in energy and maintenance cost while optimizing light quality 24/7. See ordering information or visit www.hubbellighting.com/products/sitesync for more details

NX DISTRIBUTED INTELLIGENCE™

- Hubbell Control Solutions' NX Distributed Intelligence™ lighting control platform utilizes a Distributed Network Architecture (DNA) that connects intelligent devices including luminaires, controllers, panels, occupancy sensors, photocells, wall switches and dimmers, creating a system with an unmatched level of reliability, scalability and simplicity.

DIMMING:

- Dimming range from 100% to 10% through the use of the standard 0-10V interface on the programmable driver

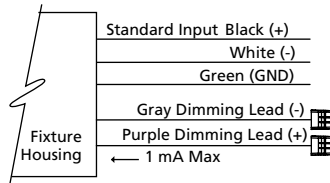

- Modular wiring harness in the service area provides user access to the dimming circuitry
- Dimming circuitry compatible with 0-10V, user-defined control devices
- Optional factory programmed dimming profile

POLE MOUNTED

ROUND POLE-MOUNTED OCCUPANCY

SENSOR UP TO 30'

SCH-R

- Round Pole Mounted Occupancy Sensor up to 30' - Outdoor occupancy sensor with 0-10V interface dimming control mounts directly to the pole. Wide 360° pattern. Module colors available Black, Gray, and White. Module is cut for round pole mounting. Pole diameter needed. Pole to be drilled in the field with provided installation instructions
- Ordering Example: SCH-R4/277²/BL³

SQUARE POLE-MOUNTED OCCUPANCY

SENSOR UP TO 30'

SCH-S

- Square Pole Mounted Occupancy Sensor up to 30' - Outdoor occupancy sensor with 0-10V interface dimming control mounts directly to the pole. Wide 360° pattern. Module colors available Black, Gray, and White. Module is cut for square pole mounting
- Ordering Example: SCH-S/277²/BL³

ASTRODIM

- AstroDIM provides multi-stage night-time power reduction based on an internal timer referenced to the power on/off time. There is no need for an external control infrastructure. The unit automatically performs a dimming profile based on the predefined scheduled reference to the midpoint, which is calculated based on the power on/off times

OPTIONAL FUSING:

- SF for 120, 277, and 347 Line volts
- DF for 208, 240, and 480 Line volts
- High temperature fuse holders factory installed inside the fixture housing
- Fuse is included

CAUTION:

- Fixtures must be grounded in accordance with national, state and/or local electrical codes. Failure to do so may result in serious personal injury

Notes:
 1 Pole diameter
 2 Voltage
 3 Color

ETA2

ARCHITECTURAL AREA/SITE

PRODUCT EXCEPTIONS & DETAILS

Configuration			EPA
	1A	1 Arm Side Mount	1.8
	1W	Single Wall Mount	n/a
	HSF	Horizontal Slipfitter	n/a

VSF/SVSF Configuration			
	1A		3T
	2B		3Y
	2L		4C

MOUNTING OPTIONS

SUPPORT ARM:

- Die-cast, low copper aluminum alloy, with splice access cover
- Die-cast pole adaptor and an internal reinforcing plate are provided with a wire strain relief
- The arm adapter is square or circular cut for specified pole size and shape
- For field wire connections, a terminal block is mounted in the arm cavity and accessible behind the splice access cover. The block accepts #14 to #8 wire sizes and is factory wired to the electrical module's quick-disconnect plug inside the electrical compartment

OPTIONAL VERTICAL SLIP-FITTER (VSF/SVSF):

- Internally accessible slip-fitter attaches to a 2-3/8" x 4" long tenon and allows hands-free wiring and maintenance
- Available for round and square poles



WALL MOUNT

1W

- A cast mounting plate of 356 alloy, low-copper (<0.6% Cu) aluminum, is mounted to the wall with bolts (by others). Fixture and arm are mounted to a cast 356 alloy aluminum cover plate before attaching to the wall mounting plate. The fixture-arm-cover plate assembly is hooked to the wall mounting plate, and secured with stainless steel screws provided. After mounting to the wall, field splices are made at the opening in the cover plate, then covered by a cast 356 alloy aluminum plate that blends with the cover plate design. Complete fixture-arm-cover plate assembly can therefore be mounted before field splices are made. Cover plate is finished to match arm and fixture powder coat color
- Optional Wall Mount: (CC is illustration the same for all site area?)
- Optional, cast aluminum mounting plate attaches to a wall over a junction box and the speed mount is bolted to the cover plate. To complete the wiring, the luminaire assembly slides over the mounting plate.

Fixture Drilling Instructions:

For AR, CC, CCS, and ET Fixtures

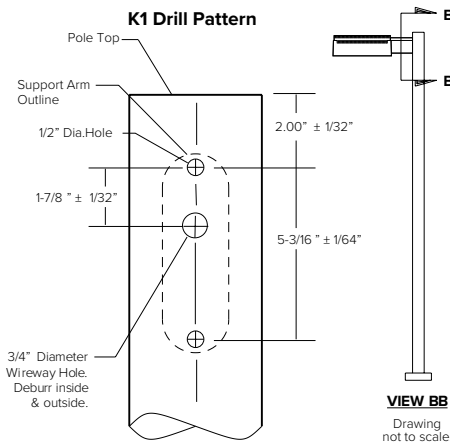

- For VSF arm configurations, please use 4". Mounting option on fixture ordering configuration. The optional VSF/SVSF will need to be ordered separately.
- SVSF use square configuration.

Ordering example for round:

- 2 - A/ETA2/54L-500/35K8/3/CLR/**4.00**/UNV/BLT
- 1 - VSF-2B

Ordering example for square:

- 2 - 1A/ETA2/54L-500/35K8/3/CLR/**SQ**/UNV/BLT
- 1 - SVSF-2SB

VSF	SVSF
VSF-1A	SVSF-1A
VSF-2B	SVSF-2B
VSF-2L	SVSF-2L
VSF-3T	SVSF-3T
VSF-3Y	SVSF-3Y
VSF-4C	SVSF-4C

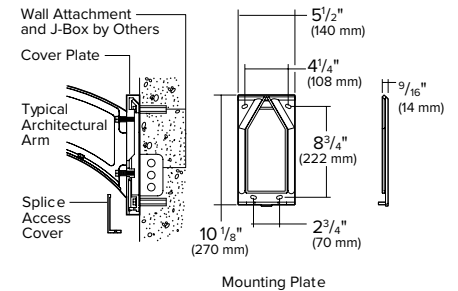

ETA2

ARCHITECTURAL AREA/SITE

PRODUCT EXCEPTIONS & DETAILS

OPTIONAL ENTABLATURES

ARCHED ENTABLATURES

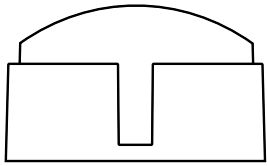

Arch Cat. No. **A1**

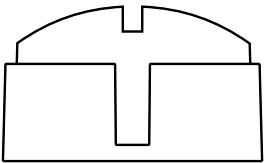

Broken Arch Cat. No. **A2**

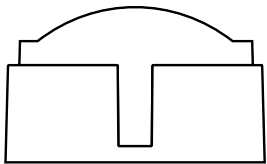

Stepped Arch Cat. No. **A3**

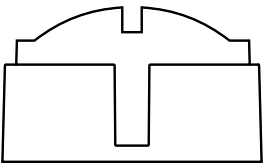

Stepped Broken Arch Cat. No. **A4**

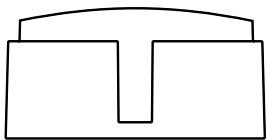

Standard Entablature Cat. No. **A5**
Follows fixture body profile

PEAKED ENTABLATURES

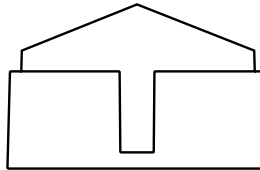

Peak Cat. No. **P6**

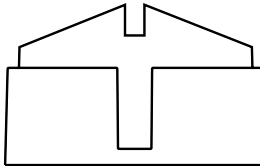

Broken Peak Cat. No. **P7**

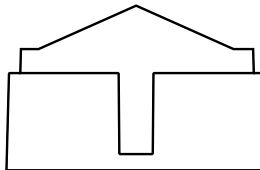

Stepped Peak Cat. No. **P8**

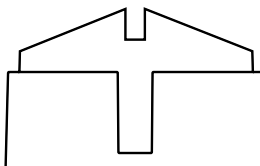

Stepped Broken Peak Cat. No. **P9**

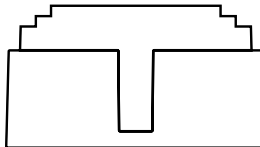

Stepped Cat. No. **P10**

DELIVERED LUMENS

NO LENS

LED #	Nominal Lumen Package	Drive Current	Distribution	3000K 70CRI					4000K 70CRI					5000K 70CRI				
				Lumen	BUG Rating			lm/w	Lumen	BUG Rating			lm/w	Lumen	BUG Rating			lm/w
					B	U	G			B	U	G			B	U	G	
54	11,000	560	1	10664	1	0	1	120.2	10802	1	0	1	121.7	11380	1	0	1	128.3
			1-BC	6020	0	0	0	67.8	6098	0	0	0	68.7	6424	0	0	1	72.4
			2	9651	2	0	2	108.8	9776	2	0	2	110.2	10299	2	0	2	116.1
			2-BC	5304	0	0	1	59.8	5373	0	0	1	60.6	5660	0	0	1	63.8
			3	9901	1	0	2	111.6	10029	1	0	2	113.0	10566	1	0	2	119.1
			3-BC	5426	0	0	2	61.2	5496	0	0	2	61.9	5791	0	0	2	65.3
			4	10301	1	0	2	116.1	10435	1	0	2	117.6	10994	1	0	2	123.9
			4-BC	7046	0	0	2	79.4	7138	0	0	2	80.4	7520	0	0	2	84.8
			4W	9545	1	0	2	107.6	9669	1	0	2	109.0	10186	1	0	2	114.8
			4W-BC	5724	0	0	2	64.5	5798	0	0	2	65.3	6108	0	0	2	68.8
			5W	9561	3	0	2	107.7	9685	3	0	2	109.1	10203	3	0	2	115.0
			5QM	10254	3	0	1	115.6	10387	3	0	1	117.1	10943	3	0	1	123.3
	R	10021	2	0	2	112.9	10151	2	0	2	114.4	10695	2	0	2	120.5		
	L	10021	1	0	2	112.9	10151	1	0	2	114.4	10695	1	0	2	120.5		
	14,000	750	1	14256	1	0	1	112.9	14441	1	0	1	114.4	15213	1	0	1	120.5
			1-BC	8048	0	0	1	63.7	8152	0	0	1	64.6	8588	0	0	1	68.0
			2	12901	2	0	2	102.2	13069	2	0	2	103.5	13768	2	0	2	109.0
			2-BC	7090	0	0	1	56.2	7183	0	0	1	56.9	7567	0	0	2	59.9
			3	13236	2	0	2	104.8	13407	2	0	2	106.2	14125	2	0	2	111.9
			3-BC	7254	0	0	2	57.4	7348	0	0	2	58.2	7741	0	0	2	61.3
			4	13771	1	0	3	109.1	13950	1	0	3	110.5	14696	1	0	3	116.4
			4-BC	9420	0	0	2	74.6	9542	0	0	2	75.6	10052	0	0	2	79.6
			4W	12760	2	0	3	101.1	12926	4	0	2	102.4	13618	2	0	3	107.8
			4W-BC	7652	0	0	2	60.6	7751	0	0	2	61.4	8166	0	0	2	64.7
5W			12781	4	0	2	101.2	12947	2	0	3	102.5	13640	4	0	2	108.0	
5QM			13708	3	0	1	108.6	13886	3	0	1	110.0	14629	4	0	1	115.9	
R	13397	2	0	2	106.1	13571	2	0	2	107.5	14297	2	0	3	113.2			
L	13397	2	0	2	106.1	13571	2	0	2	107.5	14297	2	0	3	113.2			
81	19,500	700	1	19820	2	0	1	111.2	20077	2	0	1	112.6	21151	2	0	1	118.7
			1-BC	11188	0	0	1	62.8	11334	0	0	1	63.6	11940	0	0	1	67.0
			2	17937	2	0	2	100.6	18169	2	0	2	101.9	19142	3	0	3	107.4
			2-BC	9858	0	0	2	55.3	9986	0	0	2	56.0	10520	0	0	2	59.0
			3	18402	2	0	3	103.2	18640	2	0	3	104.6	19638	2	0	3	110.2
			3-BC	10085	0	0	2	56.6	10216	0	0	2	57.3	10762	0	0	2	60.4
			4	19146	2	0	4	107.4	19395	2	0	4	108.8	20433	2	0	4	114.6
			4-BC	13096	0	0	3	73.5	13266	0	0	3	74.4	13976	0	0	3	78.4
			4W	17741	2	0	4	99.5	17971	2	0	4	100.8	18933	2	0	4	106.2
			4W-BC	10638	1	0	2	59.7	10776	1	0	3	60.5	11353	1	0	3	63.7
			5W	17769	4	0	2	99.7	18000	4	0	2	101.0	18963	4	0	2	106.4
			5QM	19058	4	0	2	106.9	19305	4	0	2	108.3	20338	4	0	2	114.1
R	18625	2	0	3	104.5	18867	2	0	3	105.9	19877	3	0	3	111.5			
L	18625	2	0	3	104.5	18867	2	0	3	105.9	19877	2	0	3	111.5			

DELIVERED LUMENS (CONTINUED)

CLR LENS

LED #	Nominal Lumen Package	Drive Current	Distribution	3000K 70CRI					4000K 70CRI					5000K 70CRI				
				Lumen	BUG Rating			lm/w	Lumen	BUG Rating			lm/w	Lumen	BUG Rating			lm/w
					B	U	G			B	U	G			B	U	G	
54	11,000	560	1	8907	1	0	1	100.4	9023	1	0	1	101.7	9506	1	0	1	107.1
			1-BC	5028	0	0	0	56.7	5094	0	0	0	57.4	5366	0	0	0	60.5
			2	8061	1	0	2	90.8	8166	1	0	2	92.0	8603	1	0	2	97.0
			2-BC	4430	0	0	1	49.9	4488	0	0	1	50.6	4728	0	0	1	53.3
			3	8270	1	0	2	93.2	8377	1	0	2	94.4	8826	1	0	2	99.5
			3-BC	4532	0	0	1	51.1	4591	0	0	1	51.7	4837	0	0	2	54.5
			4	8605	1	0	2	97.0	8716	1	0	2	98.2	9183	1	0	2	103.5
			4-BC	5885	0	0	2	66.3	5962	0	0	2	67.2	6281	0	0	2	70.8
			4W	7973	1	0	2	89.9	8076	1	0	2	91.0	8509	1	0	2	95.9
			4W-BC	4781	0	0	2	53.9	4843	0	0	2	54.6	5102	0	0	2	57.5
			5W	7986	3	0	1	90.0	8089	3	0	1	91.2	8522	3	0	2	96.0
			5QM	8565	3	0	1	96.5	8676	3	0	1	97.8	9140	3	0	1	103.0
			R	8371	3	0	1	94.3	8479	1	0	2	95.6	8933	1	0	2	100.7
			L	8371	1	0	2	94.3	8479	1	0	2	95.6	8933	1	0	2	100.7
	14,000	750	1	11907	1	0	1	94.3	12062	1	0	1	95.5	12708	1	0	1	100.6
			1-BC	6722	0	0	1	53.2	6809	0	0	1	53.9	7174	0	0	1	56.8
			2	10776	2	0	2	85.3	10916	2	0	2	86.4	11500	2	0	2	91.1
			2-BC	5923	0	0	1	46.9	5999	0	0	1	47.5	6321	0	0	1	50.1
			3	11056	1	0	2	87.6	11199	1	0	2	88.7	11798	1	0	2	93.4
			3-BC	6059	0	0	2	48.0	6137	0	0	2	48.6	6466	0	0	2	51.2
			4	11503	1	0	2	91.1	11652	1	0	2	92.3	12276	1	0	2	97.2
			4-BC	7868	0	0	2	62.3	7970	0	0	2	63.1	8397	0	0	2	66.5
			4W	10658	1	0	2	84.4	10797	1	0	2	85.5	11375	1	0	3	90.1
			4W-BC	6391	0	0	2	50.6	6474	0	0	2	51.3	6821	0	0	2	54.0
			5W	10676	3	0	2	84.5	10814	3	0	2	85.6	11393	3	0	2	90.2
			5QM	11450	3	0	1	90.7	11598	3	0	1	91.9	12219	3	0	1	96.8
R	11190	2	0	2	88.6	11335	2	0	2	89.8	11942	2	0	2	94.6			
L	11190	1	0	2	88.6	11335	1	0	2	89.8	11942	1	0	2	94.6			

ETA2

ARCHITECTURAL AREA/SITE

DELIVERED LUMENS (CONTINUED)

PL LENS

LED #	Nominal Lumen Package	Drive Current	Distribution	3000K 70CRI					4000K 70CRI					5000K 70CRI				
				Lumen	BUG Rating			lm/w	Lumen	BUG Rating			lm/w	Lumen	BUG Rating			lm/w
					B	U	G			B	U	G			B	U	G	
54	11,000	560	1	8772	1	0	1	98.9	8886	1	0	1	100.2	9362	1	0	1	105.5
			1-BC	4952	0	0	0	55.8	5016	0	0	0	56.5	5285	0	0	0	59.6
			2	7939	1	0	1	89.5	8042	1	0	2	90.6	8472	1	0	2	95.5
			2-BC	4363	0	0	1	49.2	4420	0	0	1	49.8	4656	0	0	1	52.5
			3	8145	1	0	2	91.8	8251	1	0	2	93.0	8692	1	0	2	98.0
			3-BC	4464	0	0	1	50.3	4522	0	0	1	51.0	4764	0	0	1	53.7
			4	8475	1	0	2	95.5	8584	1	0	2	96.7	9044	1	0	2	101.9
			4-BC	5797	0	0	2	65.3	5872	0	0	2	66.2	6186	0	0	2	69.7
			4W	7852	1	0	2	88.5	7954	1	0	2	89.6	8380	1	0	2	94.4
			4W-BC	4709	0	0	2	53.1	4770	0	0	2	53.8	5025	0	0	2	56.6
			5W	7865	3	0	1	88.6	7967	3	0	1	89.8	8393	3	0	2	94.6
			5QM	8435	3	0	1	95.1	8545	3	0	1	96.3	9002	3	0	1	101.5
			R	8244	1	0	2	92.9	8351	1	0	2	94.1	8798	1	0	2	99.2
			L	8244	1	0	2	92.9	8351	1	0	2	94.1	8798	1	0	2	99.2
	14,000	750	1	11727	1	0	1	92.9	11880	1	0	1	94.1	12515	1	0	1	99.1
			1-BC	6620	0	0	1	52.4	6706	0	0	1	53.1	7065	0	0	1	56.0
			2	10613	2	0	2	84.1	10751	2	0	2	85.1	11326	2	0	2	89.7
			2-BC	5833	0	0	1	46.2	5909	0	0	1	46.8	6225	0	0	1	49.3
			3	10888	1	0	2	86.2	11030	1	0	2	87.3	11620	1	0	2	92.0
			3-BC	5967	0	0	2	47.3	6045	0	0	2	47.9	6368	0	0	2	50.4
			4	11329	1	0	2	89.7	11476	1	0	2	90.9	12090	1	0	2	95.7
			4-BC	7749	0	0	2	61.4	7849	0	0	2	62.2	8270	0	0	2	65.5
			4W	10497	1	0	2	83.1	10633	1	0	2	84.2	11203	1	0	3	88.7
			4W-BC	6295	0	0	2	49.8	6376	0	0	2	50.5	6718	0	0	2	53.2
			5W	10514	3	0	2	83.3	10651	3	0	2	84.3	11221	3	0	2	88.9
			5QM	11277	3	0	1	89.3	11423	3	0	1	90.5	12034	3	0	1	95.3
R	11021	2	0	2	87.3	11164	2	0	2	88.4	11761	2	0	2	93.1			
L	11021	1	0	2	87.3	11164	1	0	2	88.4	11761	1	0	2	93.1			

DIMENSIONS

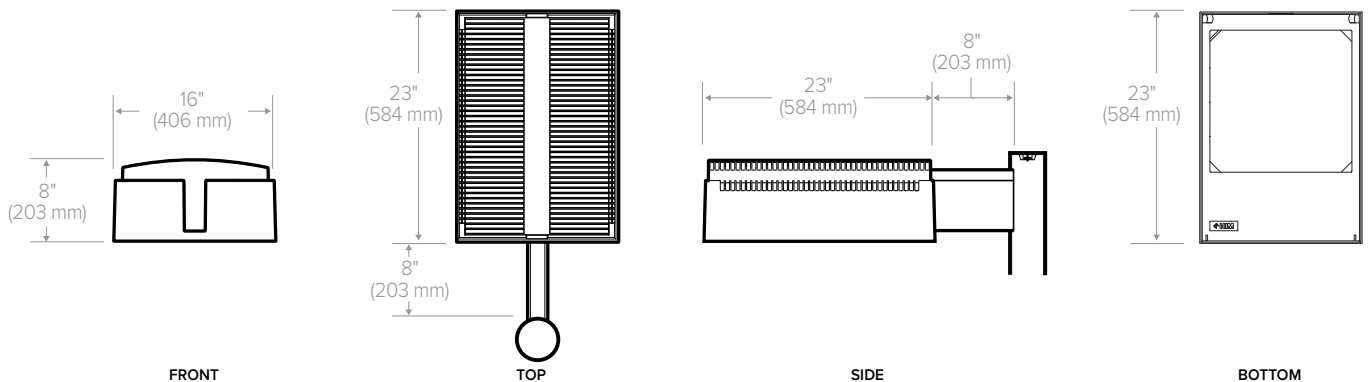

ETA2

ARCHITECTURAL AREA/SITE

PHOTOMETRY

ET2-54L-750-4K7-1

LUMINAIRE DATA

Description	4000K, 70CRI
Delivered Lumens	14440
Watts	126.27
Efficacy	114.4
IES Type	1
BUG Rating	B1-U0-G1
Mounting Height	15 ft
Grid Scale	10 ft

ZONAL LUMEN SUMMARY

Zone	Lumens	% Luminaire
Downward Street Side	12851	89.0%
Downward House Side	1589	11.0%
Downward Total	14440	100.0%
Upward Street Side	0	0.0%
Upward House Side	0	0.0%
Upward Total	0	0.0%
Total Flux	14440	100%

ISOFOOT CANDLE PLOT

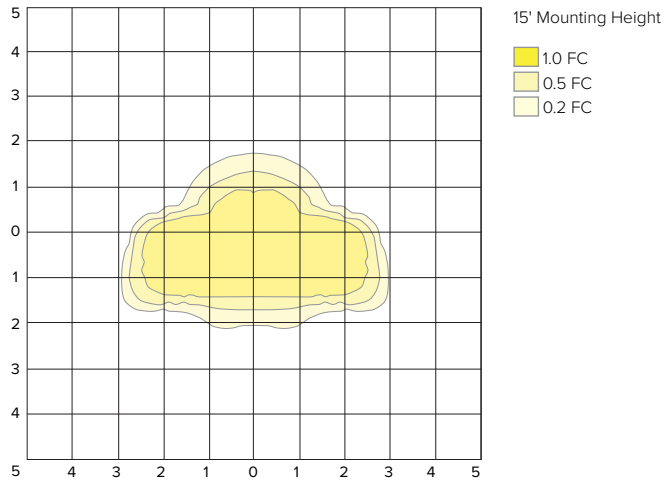

ET2-54L-750-4K7-1-BC

LUMINAIRE DATA

Description	4000K, 70CRI
Delivered Lumens	8151
Watts	126.27
Efficacy	64.6
IES Type	1
BUG Rating	B0-U0-G1
Mounting Height	15 ft
Grid Scale	10 ft

ZONAL LUMEN SUMMARY

Zone	Lumens	% Luminaire
Downward Street Side	8033	98.5%
Downward House Side	118	1.5%
Downward Total	8151	100.0%
Upward Street Side	0	0.0%
Upward House Side	0	0.0%
Upward Total	0	0.0%
Total Flux	8151	100%

ISOFOOT CANDLE PLOT

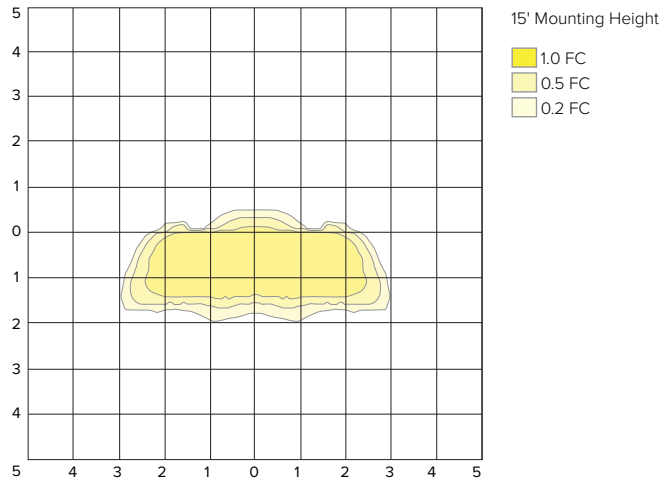

ET2-54L-750-4K7-2

LUMINAIRE DATA

Description	4000K, 70CRI
Delivered Lumens	13069
Watts	126.27
Efficacy	103.5
IES Type	2
BUG Rating	B2-U0-G2
Mounting Height	15 ft
Grid Scale	10 ft

ZONAL LUMEN SUMMARY

Zone	Lumens	% Luminaire
Downward Street Side	10825	82.8%
Downward House Side	2245	17.2%
Downward Total	13069	100.0%
Upward Street Side	0	0.0%
Upward House Side	0	0.0%
Upward Total	0	0.0%
Total Flux	13069	100%

ISOFOOT CANDLE PLOT

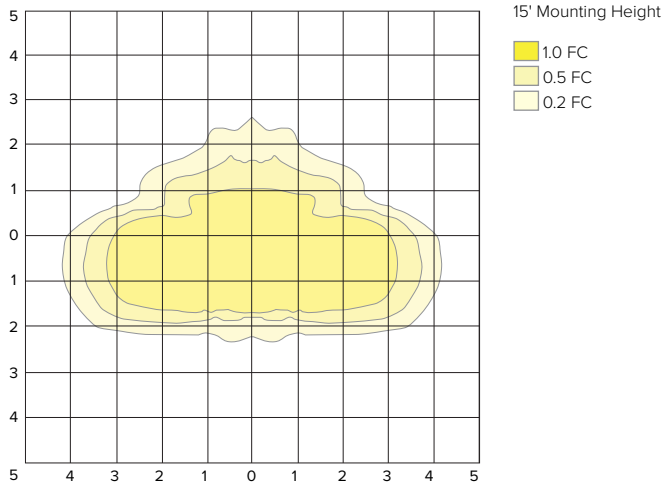

ETA2

ARCHITECTURAL AREA/SITE

PHOTOMETRY

ET2-54L-750-4K7-2-BC

LUMINAIRE DATA

Description	4000K, 70CRI
Delivered Lumens	7182
Watts	126.27
Efficacy	56.9
IES Type	2
BUG Rating	B0-U0-G1
Mounting Height	15 ft
Grid Scale	10 ft

ZONAL LUMEN SUMMARY

Zone	Lumens	% Luminaire
Downward Street Side	7019	97.7%
Downward House Side	163	2.3%
Downward Total	7182	100.0%
Upward Street Side	0	0.0%
Upward House Side	0	0.0%
Upward Total	0	0.0%
Total Flux	7182	100%

ISOFOOT CANDLE PLOT

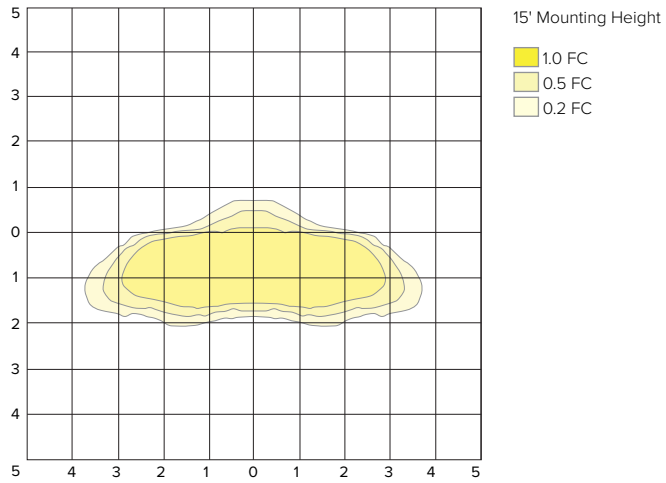

ET2-54L-750-4K7-3

LUMINAIRE DATA

Description	4000K, 70CRI
Delivered Lumens	13406
Watts	126.27
Efficacy	106.2
IES Type	3
BUG Rating	B2-U0-G2
Mounting Height	15 ft
Grid Scale	10 ft

ZONAL LUMEN SUMMARY

Zone	Lumens	% Luminaire
Downward Street Side	11502	85.8%
Downward House Side	1904	14.2%
Downward Total	13406	100.0%
Upward Street Side	0	0.0%
Upward House Side	0	0.0%
Upward Total	0	0.0%
Total Flux	13406	100%

ISOFOOT CANDLE PLOT

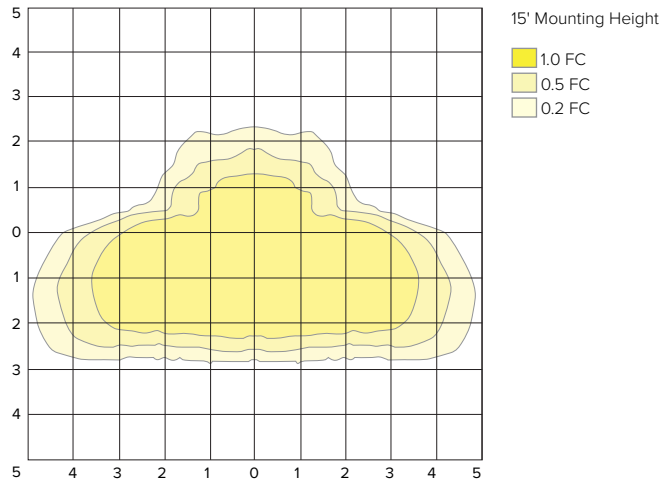

ET2-54L-750-4K7-3-BC

LUMINAIRE DATA

Description	4000K, 70CRI
Delivered Lumens	7347
Watts	126.27
Efficacy	58.2
IES Type	3
BUG Rating	B0-U0-G2
Mounting Height	15 ft
Grid Scale	10 ft

ZONAL LUMEN SUMMARY

Zone	Lumens	% Luminaire
Downward Street Side	7108	96.7%
Downward House Side	239	3.3%
Downward Total	7347	100.0%
Upward Street Side	0	0.0%
Upward House Side	0	0.0%
Upward Total	0	0.0%
Total Flux	7347	100%

ISOFOOT CANDLE PLOT

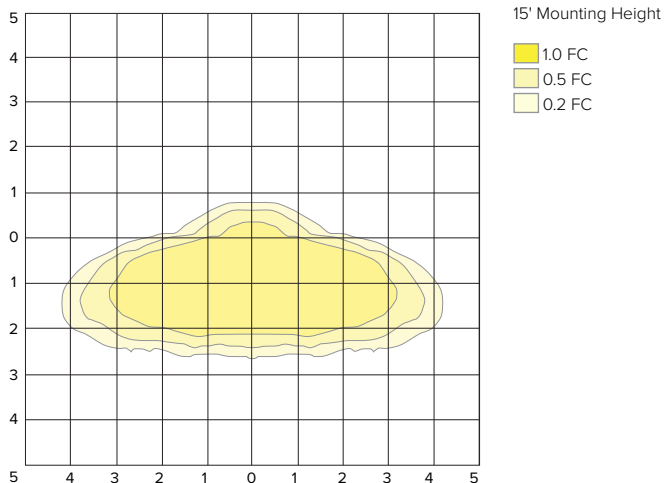

ETA2

ARCHITECTURAL AREA/SITE

PHOTOMETRY

ET2-54L-750-4K7-4

LUMINAIRE DATA

Description	4000K, 70CRI
Delivered Lumens	13950
Watts	126.27
Efficacy	110.5
IES Type	4
BUG Rating	B1-U0-G3
Mounting Height	15 ft
Grid Scale	10 ft

ZONAL LUMEN SUMMARY

Zone	Lumens	% Luminaire
Downward Street Side	12630	87.6%
Downward House Side	1321	12.4%
Downward Total	13951	100.0%
Upward Street Side	0	0.0%
Upward House Side	0	0.0%
Upward Total	0	0.0%
Total Flux	13951	100%

ISOFOOT CANDLE PLOT

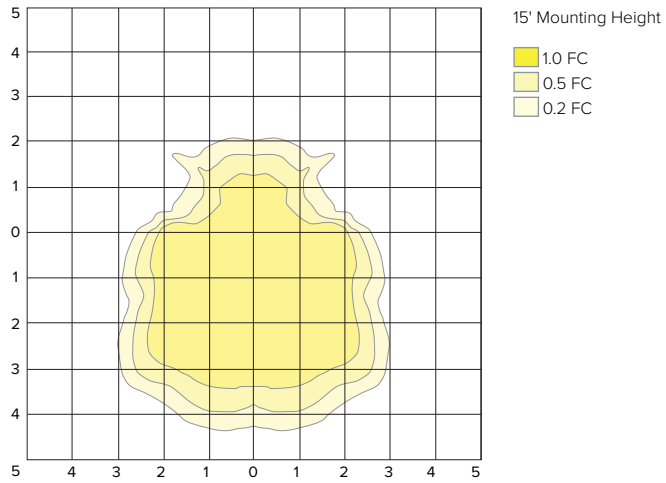

ET2-54L-750-4K7-4-BC

LUMINAIRE DATA

Description	4000K, 70CRI
Delivered Lumens	9542
Watts	126.27
Efficacy	75.6
IES Type	4
BUG Rating	B0-U0-G2
Mounting Height	15 ft
Grid Scale	10 ft

ZONAL LUMEN SUMMARY

Zone	Lumens	% Luminaire
Downward Street Side	9312	87.6%
Downward House Side	231	12.4%
Downward Total	9543	100.0%
Upward Street Side	0	0.0%
Upward House Side	0	0.0%
Upward Total	0	0.0%
Total Flux	9543	100%

ISOFOOT CANDLE PLOT

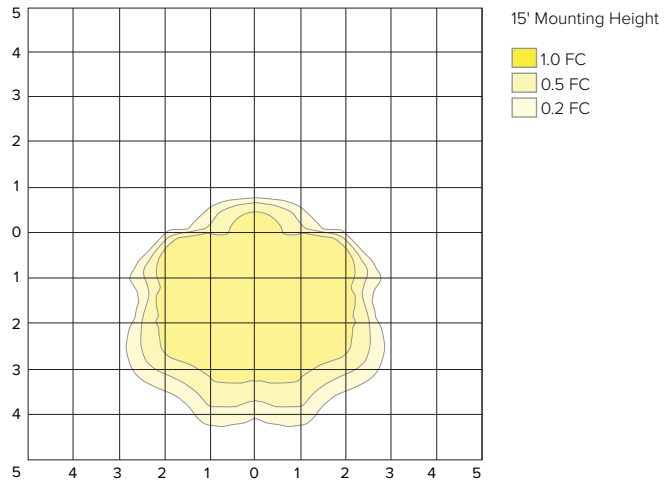

ET2-54L-750-4K7-4W

LUMINAIRE DATA

Description	4000K, 70CRI
Delivered Lumens	12926
Watts	126.27
Efficacy	102.4
IES Type	4W
BUG Rating	B2-U0-G3
Mounting Height	15 ft
Grid Scale	10 ft

ZONAL LUMEN SUMMARY

Zone	Lumens	% Luminaire
Downward Street Side	11324	87.6%
Downward House Side	1602	12.4%
Downward Total	12926	100.0%
Upward Street Side	0	0.0%
Upward House Side	0	0.0%
Upward Total	0	0.0%
Total Flux	12926	100%

ISOFOOT CANDLE PLOT

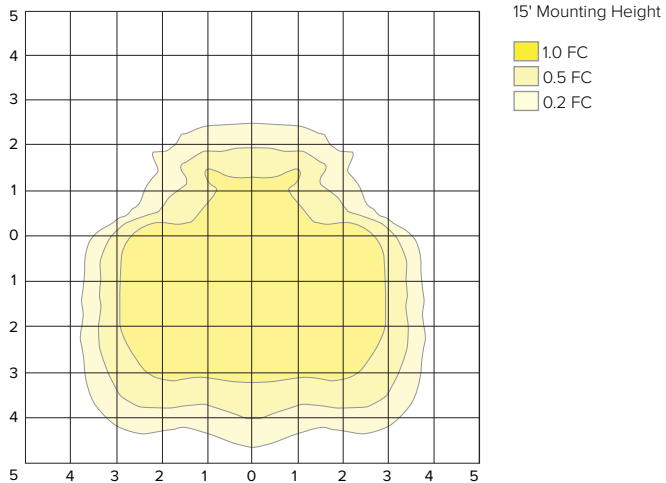

ETA2

ARCHITECTURAL AREA/SITE

PHOTOMETRY

ET2-54L-750-4K7-4W-BC

LUMINAIRE DATA

Description	4000K, 70CRI
Delivered Lumens	7750
Watts	126.27
Efficacy	61.4
IES Type	4W
BUG Rating	B0-U0-G2
Mounting Height	15 ft
Grid Scale	10 ft

ZONAL LUMEN SUMMARY

Zone	Lumens	% Luminaire
Downward Street Side	7449	96.0%
Downward House Side	301	4.0%
Downward Total	7750	100.0%
Upward Street Side	0	0.0%
Upward House Side	0	0.0%
Upward Total	0	0.0%
Total Flux	7750	100%

ISOFOOT CANDLE PLOT

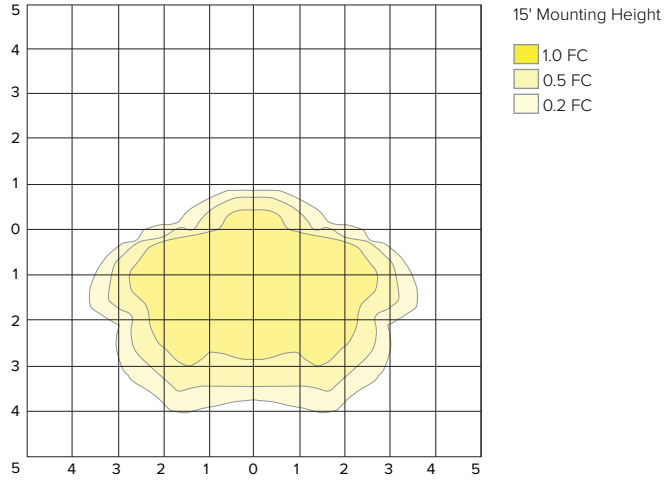

ET2-54L-750-4K7-5QM

LUMINAIRE DATA

Description	4000K, 70CRI
Delivered Lumens	13885
Watts	126.27
Efficacy	110.0
IES Type	5
BUG Rating	B3-U0-G1
Mounting Height	15 ft
Grid Scale	10 ft

ZONAL LUMEN SUMMARY

Zone	Lumens	% Luminaire
Downward Street Side	6943	50.0%
Downward House Side	6942	50.0%
Downward Total	13885	100.0%
Upward Street Side	0	0.0%
Upward House Side	0	0.0%
Upward Total	0	0.0%
Total Flux	13885	100%

ISOFOOT CANDLE PLOT

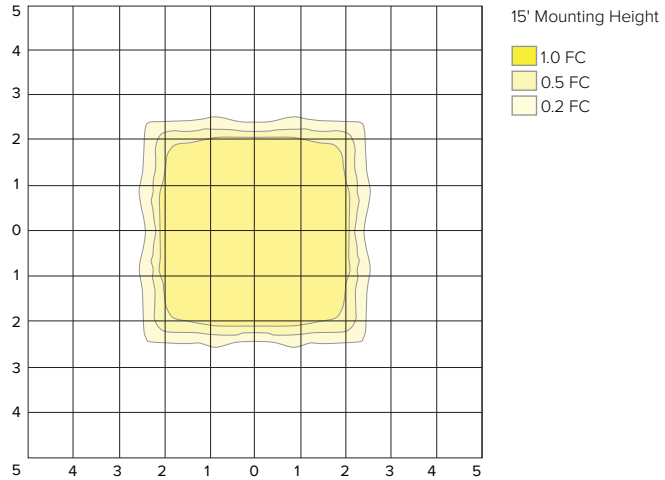

ET2-54L-750-4K7-5W

LUMINAIRE DATA

Description	4000K, 70CRI
Delivered Lumens	12946
Watts	126.27
Efficacy	102.5
IES Type	5
BUG Rating	B4-U0-G2
Mounting Height	15 ft
Grid Scale	10 ft

ZONAL LUMEN SUMMARY

Zone	Lumens	% Luminaire
Downward Street Side	6473	50.0%
Downward House Side	6473	50.0%
Downward Total	12946	100.0%
Upward Street Side	0	0.0%
Upward House Side	0	0.0%
Upward Total	0	0.0%
Total Flux	12946	100%

ISOFOOT CANDLE PLOT

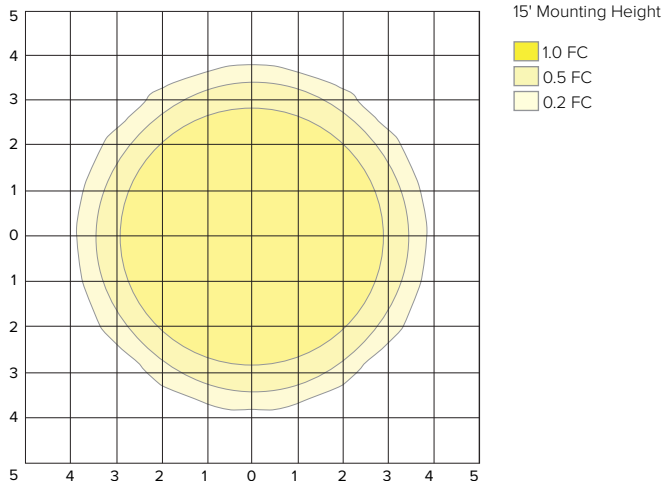

ETA2

ARCHITECTURAL AREA/SITE

PHOTOMETRY

ET2-54L-750-4K7-R

LUMINAIRE DATA

Description	4000K, 70CRI
Delivered Lumens	13570
Watts	126.27
Efficacy	107.5
IES Type	R
BUG Rating	B2-U0-G2
Mounting Height	15 ft
Grid Scale	10 ft

ZONAL LUMEN SUMMARY

Zone	Lumens	% Luminaire
Downward Street Side	11231	82.8%
Downward House Side	2339	17.2%
Downward Total	13570	100.0%
Upward Street Side	0	0.0%
Upward House Side	0	0.0%
Upward Total	0	0.0%
Total Flux	13570	100%

ISOFOOT CANDLE PLOT

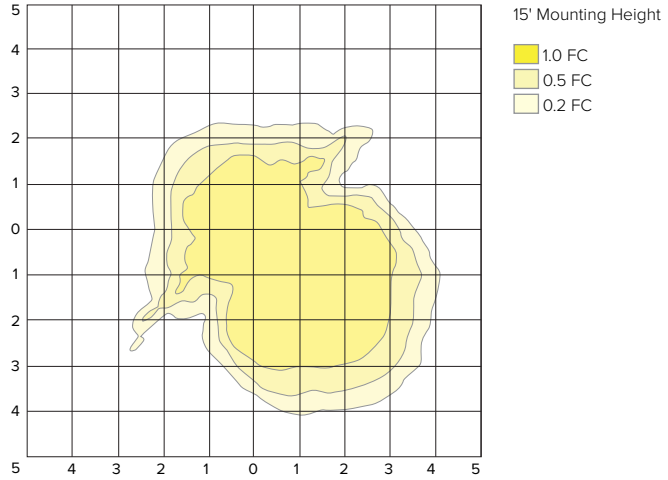

ET2-54L-750-4K7-L

LUMINAIRE DATA

Description	4000K, 70CRI
Delivered Lumens	13571
Watts	126.27
Efficacy	107.5
IES Type	L
BUG Rating	B2-U0-G2
Mounting Height	15 ft
Grid Scale	10 ft

ZONAL LUMEN SUMMARY

Zone	Lumens	% Luminaire
Downward Street Side	11523	84.9%
Downward House Side	2048	15.1%
Downward Total	13571	100.0%
Upward Street Side	0	0.0%
Upward House Side	0	0.0%
Upward Total	0	0.0%
Total Flux	13571	100%

ISOFOOT CANDLE PLOT

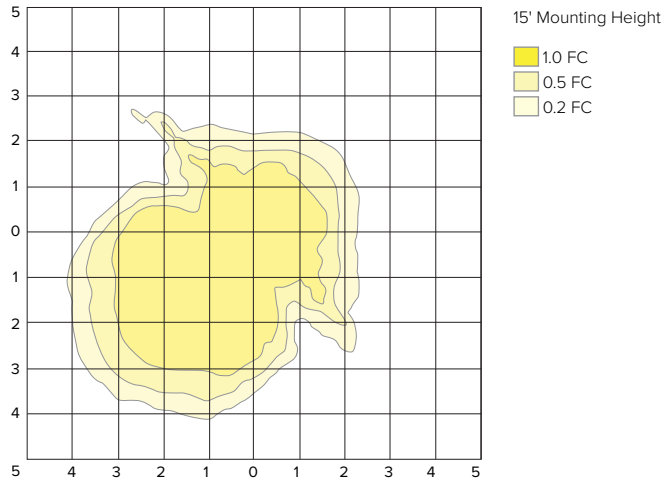

ETA2

ARCHITECTURAL AREA/SITE

TM-30 DATA

COLOR VECTOR GRAPHIC

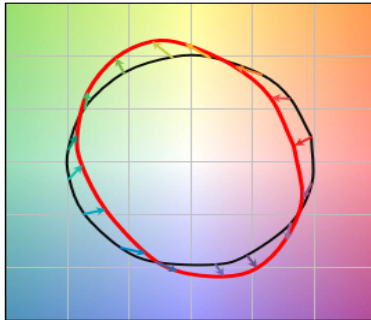

— Reference Illuminant — Test Source

TEST SOURCE

R _f	68
R _g	99
CCT(K)	3947
D _{uv}	0.0004
x	0.3831
y	0.3793
CIE R _a	72

SPECTRAL POWER DISTRIBUTION COMPARISON

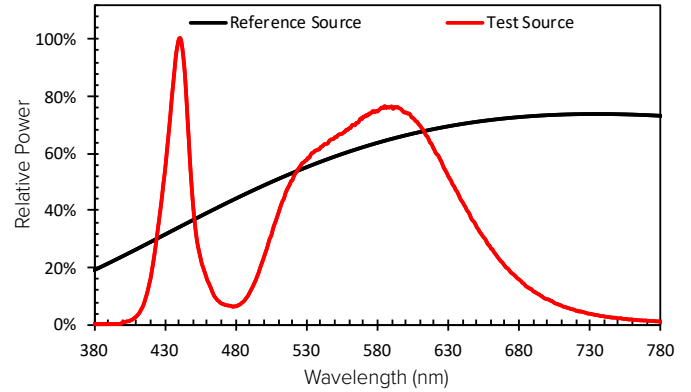

AMBER SPECTRAL POWER DISTRIBUTION

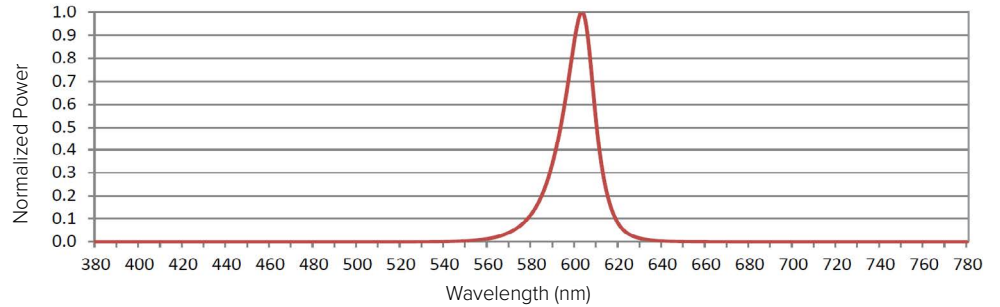

ELECTRICAL DATA

LED Count	System Watts	Current	Line Voltage		Amps AC						Min Power Factor	Max. THD (%)	Dimming				
			VAC	Hz	120	208	240	277	347	480			Dimming Range	Source Current Out		Absolute Voltage	
														Min	Max	Min	Max
54 LEDs	88.7	560 mA	120-480	50/60	0.74	0.43	0.37	0.32	0.26	0.18	>0.9	20	10% to 100%	0mA	1mA	0V	10V
	126.3	750 mA			1.05	0.61	0.53	0.46	0.36	0.26							
81 LEDs	178.2	700 mA			1.49	0.86	0.74	0.64	0.51	0.37							

TM-21 Lifetime Calculation - Projected Lumen Maintenance (25°C / 77°C)						
Ambient Temp.	0	25,000	36,000	50,000	100,000	Reported L70
25°C / 77°F	100%	94.22%	92.26%	89.84%	81.68%	>60khrs

CRI Lumen Multiplier for 80 and 90 CRI		
CCT	80 CRI	90 CRI
2700K	0.859	0.655
3000K	0.919	.7033
3500K	0.906	0.732
4000K	0.8941	.734
5000K	0.879	.7712
Scaling factor of 5000K 70CRI lumen packages		