

DATE: _____ LOCATION: _____
 TYPE: _____ PROJECT: _____
 CATALOG #: _____

FEATURES

- -5° to +10° tilt adjustment
- High performance optics deliver up to 7,500 lumens
- up or down mountable without modification
- Programmable occupancy sensor (dimming)
- NX and SiteSync wireless controls
- 130+ lumens per watt
- UL/cUL listed for wet locations, IP66 Listed



CONTROL TECHNOLOGY



SPECIFICATIONS

CONSTRUCTION

- Optical housing is a one-piece, die-cast low copper (<0.6%) aluminum alloy with integral heat sink. The housing rotates against mounting arm housing to provide -5° to 10° of adjustment with degree markers label. At 0° adjustment, lens is totally concealed from view above horizontal with fixture mounted in the downward position.
- Mounting arm housing is one-piece die-cast, low copper (<0.6%) aluminum alloy with provisions for tilt mechanism. Mounting arm fastens to the mounting plate with keyhole slots freeing both hands for securing and wiring. One stainless steel socket-head screw on the tilt mechanism frees the optical housing to rotate for aiming. Tightening the screws locks the housing and lens frame together with sealing provided by a silicone gasket. For visual aiming, adjustment may be accomplished with the fixture on.
- Lens Frame is a one-piece, die-cast low copper (<0.6%) aluminum alloy with integral cooling fins to dissipate driver thermal.
- Bracketry and hardware shall be stainless steel.
- Finish: fade and abrasion resistant, electrostatically applied, thermally cured, triglycidal isocyanurate (TGIC) polyester powdercoat

OPTICS

- LEDs mount to a metal printed circuit board assembly (MCPCB).
- Optical lenses are clear injection molded PMMA acrylic.
- Secondary lens is impact resistant 1/8" tempered glass with anti-reflective coating.

INSTALLATION

- Junction box (by others): Standard with steel, quick-mount junction box plate that mounts directly to 4" J-Box.
- Mounting plate is stainless steel and features a one-piece EPDM gasket on back side of plate to firmly seal fixture to wall surface, forbidding entry of moisture and particulates.
- Fixtures must be grounded in accordance with national, state and/or local electrical codes. Failure to do so may result in serious personal injury.

SERVICING

- Housing should hang freely in an open service position for inspection of primary wire connections. Once in service position, the housing can be removed for service by sliding the assembly to the left (for down mounting) or to the right (for up mounting) and disconnecting the wiring plugs.
- Driver assembly shall be mounted to a prewired internal tray with quick disconnects for removal.

Wall Director

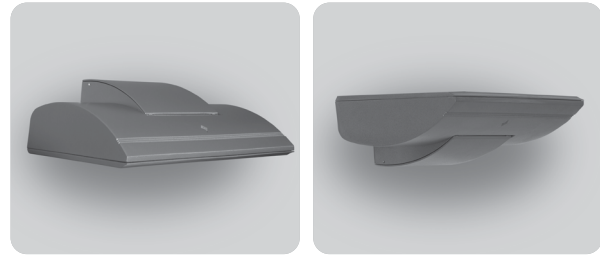

Wall Director Small

RELATED PRODUCTS

[Wall Director Medium](#)

ELECTRICAL

- Universal voltage, 120 through 277V with a ±10% tolerance. Driver is Underwriters Laboratories listed.
- High voltage configurations, 347/480. Driver has a 0-10V dimming interface for multi-level illumination options. Driver is Underwriters Laboratories listed.
- "Thermal Shield", secondary side, thermistor provides protection for the sustainable life of LED module and electronic components
- Drivers shall have greater than a 0.9 power factor, less than 20% harmonic distortion, and be suitable for operation in -40°C to 40°C ambient environments
- Luminaire shall be capable of operating at 100% brightness in a 40°C environment. Both driver and optical array have integral thermal protection that will dim the luminaire upon detection of temperatures in excess of 85°C
- Modular wiring harness in the service area provides user access to the dimming circuitry
- Optional factory programmed dimming profile
- Surge protection: 10,000k in parallel, 20,000k in series
- Wiring: No. 18AWM rated 90°C, wet rating.

(Specifications continued on page 3)

KEY DATA	
Lumen Range	2,855–8,567
Wattage Range	29–74
Efficacy Range (LPW)	89–129
Reported Life (Hours)	L70/60,000
Weight	20 lbs/9.07 kg

DATE: _____ LOCATION: _____
 TYPE: _____ PROJECT: _____
 CATALOG #: _____

ORDERING GUIDE

Example: WDS-D-24L-30-3K7-1-UNV-BLS-PC-EM-SWUSB

CATALOG #

HOUSING

WDS		Mounting		Source		Wattage		Light Engine		Distribution	
WDS	WallDirector Small	D	Down	24L	24 LEDs	30	30 Watts, 3000 lm	AM ⁶	Monochromatic Amber	1	Type I
		U ¹	Up			40	40 Watts, 4500 lm	3K7	3000K/70CRI	2	Type II
						60	60 Watts, 6000 lm	3K8	3000K/80CRI	3	Type III
						75	75 Watts, 7500 lm	4K7	4000K/70CRI	4W	Type IV Wide
								4K8	4000K/80CRI	4F	Type IV Forward
								5K7	5000K/70CRI	WG ²	Wall Graze
								SP	Spot/Column		
										FTD ²	Forward Throw Diffuse
										WTD ²	Wide Throw Diffuse

Voltage		Fixture Finish		Control Options		Options		Control Accessories	
UNV	120-277V	BLS	Black Gloss Smooth	PC ¹¹	Button Photocell	EM ³	Integral Battery Backup Unit (8W)	SCPREMOTE	SCP configuration tool
347 ^{3,10}	347V	BLT	Black Matte Textured	SCP-8F ^{3,4,5,9}	Programmable Occ. Sensor (<9' height)	SF	Single Fuse & Fuse holder	SWUSB	SiteSync Software on USB
480 ^{3,10}	480V	DBS	Dark Bronze Gloss Smooth	SCP-20F ^{3,4,5,9}	Programmable Occ. Sensor (9' - 20' height)	DF	Double Fuse & Fuse holder	SWTAB	SiteSync Windows [®] Tablet
		DBT	Dark Bronze Matte Textured	SWP ^{3,4,5,7}	SiteSync Wireless Pre-Commission	SCM1	1/2" Surface Conduit Mount	SWBRG	SiteSync Software Bridge Node
		GTT	Graphite Matte Textured	NXWE ^{4,5}	NX Wireless Enabled	SCM2	3/4" Surface Conduit Mount		
		LGS	Light Grey Gloss Smooth						
		LGT	Light Grey Matte Textured						
		PSS	Platinum Silver Gloss Smooth						
		VGT	Verde Green Matte Textured						
		WHS	White Gloss Smooth						
		WHT	White Matte Textured						
		Color Option							
		CC ⁸	Custom Color						

Notes:

- 1 Not available with EM option or with SCP,SWPM, NXSPW14 and NXSP14F sensor options.
- 2 WG, FTD, and WTD come with a diffused lens
- 3 Not available with other control options and Integral Battery Backup Unit
- 4 Input voltage 120-347V
- 5 Not available in 480V
- 6 Turtle friendly
- 7 Specify group and zone at time of order. See www.hubbellighting.com/sitesync for more details. Order at least one SiteSync interface accessory SWUSB or SWTAB. Each option contains SiteSync License, GUI, and Bridge Node
- 8 Consult factory for custom color, marine and corrosive finish options
- 9 SCPREMOTE SCP configuration tool needed
- 10 Not available with 30 watt or 40 watts
- 11 PC not available with EM

Microsoft, Encarta, MSN, and Windows are either registered trademarks or trademarks of Microsoft Corporation in the United States and/or other countries.

SPECIFICATIONS (CONT')

DIMMING:

- Dimming range from 100% to 10% through the use of the standard 0-10V interface on the programmable driver.

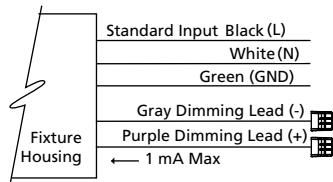

- Modular wiring harness in the service area provides user access to the dimming circuitry.
- Dimming circuitry compatible with 0-10V, user-defined control devices.
- Optional factory programmed dimming profile.

BUTTON PHOTOCELL

- Optional universal voltage (120-277V) button photocontrol for dusk to dawn energy savings. Photocontrol is factory installed inside the housing with a fully gasketed sensor on the side wall. For multiple fixture mountings, one fixture is supplied with a photocell to operate the others.

WIRELESS CONTROLS SITESYNC™

- SiteSync™ wireless control system for reduction in energy and maintenance cost while optimizing light quality 24/7. See ordering information or visit www.hubbellighting.com/products/sitesync for more details.

NX DISTRIBUTED INTELLIGENCE™

- Hubbell Control Solutions' NX Distributed Intelligence™ lighting control platform utilizes a Distributed Network Architecture (DNA) that connects intelligent devices including luminaires, controllers, panels, occupancy sensors, photocells, wall switches and dimmers, creating a system with an unmatched level of reliability, scalability and simplicity

OPTIONAL FUSING:

- SF for 120, 277, and 347 Line volts
- DF for 208, 240, and 480 Line volts
- High temperature fuse holders factory installed inside the fixture housing.
- Fuse is included.

OPTIONAL BACKUP BATTERY

- Integral battery backup provides emergency path of egress lighting for the required 90 minutes for 0°C ambient.

CAUTION:

- Fixtures must be grounded in accordance with national, state and/or local electrical codes. Failure to do so may result in serious personal injury.

CERTIFICATIONS AND LISTINGS

- Listed to UL1598 and CSA C22.2#250.0-24 for wet locations and 40°C ambient temperatures
- IEC 66262 Mechanical Impact Code IK08
- IP66 certified
- RoHS compliant
- This product qualifies as a “designated country construction material” per FAR 52.225-11 Buy American-Construction Materials under Trade Agreements effective 04/16/2020. [See Buy American Solutions.](#)

WARRANTY

- 5 year warranty
- See [HLI Standard Warranty](#) for additional information
- †PRECOMMISSIONED SITESYNC ORDERING INFORMATION: When ordering a fixture with the SiteSync lighting control option, additional information will be required to complete the order. The SiteSync Commissioning Form or alternate schedule information must be completed. This form includes Project location, Group information, and Operating schedules. For more detailed information please visit www.HubbellLighting.com/products/sitesync or contact Hubbell Lighting tech support at (800) 345-4928
- Examples:
WDS-D-48L-55-3K7-1-UNV-BLS-PC-SF

DIMENSIONS

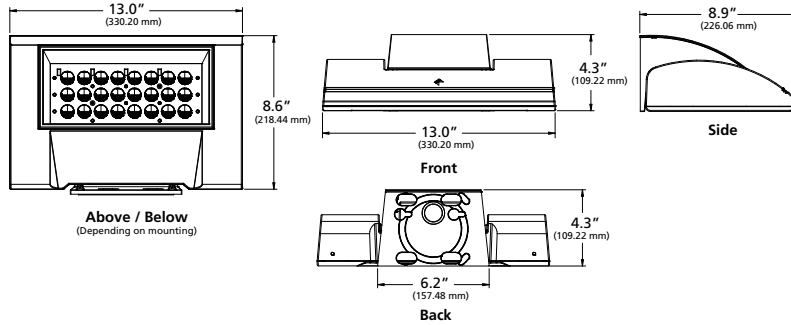

Weight: 20 lbs

DELIVERED LUMENS

LEDs #	Drive Current	Lumens Package	Nominal Watts	Lens Options	Distribution	3000K 70CRI				4000K 70CRI				5000K 70CRI							
						Lumen	BUG Rating			lm/w	Lumen	BUG Rating			lm/w	Lumen	BUG Rating			lm/w	
							B	U	G			B	U	G			B	U	G		
24L	350mA	3,000	30	Clear	1	3433	1	0	0	119	3519	1	0	0	122	3560	1	0	0	123	
					2	3351	1	0	1	116	3436	1	0	1	119	3475	1	0	1	120	
					3	3340	1	0	1	116	3424	1	0	1	119	3463	1	0	1	120	
					4F	3343	1	0	1	116	3427	1	0	1	119	3466	1	0	1	120	
					4W	3267	1	0	1	113	3349	1	0	1	116	3387	1	0	1	117	
					SP	3600	3	0	0	125	3691	3	0	0	128	3733	3	0	0	129	
				Diffused	WG	3144	1	0	1	109	3223	2	0	1	112	3260	2	0	1	113	
					FTD	2855	1	0	1	99	2927	1	0	1	101	2960	1	0	1	103	
						WTD	3151	1	0	1	109	3230	1	0	1	112	3267	1	0	1	113
	500mA	4,500	40	Clear	1	4593	1	0	0	111	4708	1	0	0	113	4762	1	0	0	115	
					2	4484	1	0	1	108	4596	1	0	1	111	4649	1	0	1	112	
					3	4468	1	0	1	108	4581	1	0	1	110	4633	1	0	1	112	
					4F	4472	1	0	1	108	4585	1	0	1	110	4637	1	0	1	112	
					4W	4370	1	0	2	105	4480	1	0	2	108	4531	1	0	2	109	
SP					4817	3	0	0	116	4938	3	0	0	119	4994	3	0	0	120		
Diffused				WG	4206	2	0	1	101	4312	2	0	1	104	4361	2	0	1	105		
				FTD	3819	1	0	1	92	3915	1	0	1	94	3960	1	0	1	95		
					WTD	4215	1	0	1	102	4321	1	0	1	104	4371	1	0	1	105	

DELIVERED LUMENS (CONTINUED)

LEDs #	Drive Current	Lumens Package	Nominal Watts	Lens Options	Distribution	3000K 70CRI				4000K 70CRI				5000K 70CRI							
						Lumen	BUG Rating			lm/w	Lumen	BUG Rating			lm/w	Lumen	BUG Rating			lm/w	
							B	U	G			B	U	G			B	U	G		
24L	725mA	6,000	60	Clear	1	6333	1	0	1	108	6492	1	0	1	111	6566	1	0	1	112	
					2	6182	1	0	1	106	6338	1	0	1	108	6410	1	0	1	110	
					3	6161	1	0	2	105	6316	1	0	2	108	6388	1	0	2	109	
					4F	6166	1	0	2	105	6321	1	0	2	108	6393	1	0	2	109	
					4W	6025	1	0	2	103	6177	1	0	2	106	6248	1	0	2	107	
					SP	6641	4	0	0	114	6808	4	0	0	116	6886	4	0	0	118	
					Diffused	WG	5800	2	0	1	99	5945	2	0	1	102	6013	2	0	1	103
						FTD	5266	1	0	1	90	5398	2	0	1	92	5460	2	0	1	93
	WTD	5812	1	0	1	99	5958	1	0	1	102	6026	1	0	1	103					
	925mA	7,500	75	Clear	1	7879	1	0	1	106	8077	1	0	1	109	8170	1	0	1	110	
					2	7692	1	0	1	104	7885	1	0	1	107	7975	1	0	2	108	
					3	7665	1	0	2	104	7858	1	0	2	106	7948	1	0	2	107	
					4F	7672	1	0	2	104	7865	1	0	2	106	7955	1	0	2	107	
					4W	7497	1	0	2	101	7685	1	0	2	104	7773	1	0	2	105	
SP					8263	4	0	0	112	8471	4	0	0	114	8567	4	0	0	116		
Diffused					WG	7216	3	0	1	98	7397	3	0	1	100	7482	3	0	1	101	
					FTD	6552	2	0	1	89	6717	2	0	1	91	6793	2	0	2	92	
WTD	7231	2	0	1	98	7413	2	0	1	100	7498	2	0	1	101						

WDS

WALL MOUNTED

PHOTOMETRY

WDS-D-24L-75-4K7-1

LUMINAIRE DATA

Description	4000K, 70CRI
Delivered Lumens	8077
Watts	74
Efficacy	109.1
IES Type	I
BUG Rating	B1-U0-G1
Mounting Height	15 ft
Grid Scale	15 ft

ZONAL LUMEN SUMMARY

Zone	Lumens	% Luminaire
Downward Street Side	7166	88.7%
Downward House Side	912	11.3%
Downward Total	8077	100%
Upward Street Side	0	0%
Upward House Side	0	0%
Upward Total	0	0%
Total Flux	8077	100%

ISOFOOT CANDLE PLOT

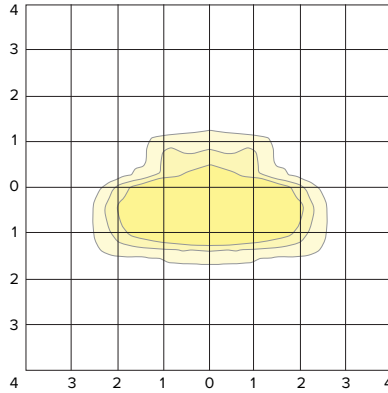

WDS-D-24L-75-4K7-2

LUMINAIRE DATA

Description	4000K, 70CRI
Delivered Lumens	7885
Watts	74
Efficacy	106.6
IES Type	II
BUG Rating	B1-U0-G1
Mounting Height	15 ft
Grid Scale	15 ft

ZONAL LUMEN SUMMARY

Zone	Lumens	% Luminaire
Downward Street Side	6393	81.1%
Downward House Side	1492	18.9%
Downward Total	7885	100%
Upward Street Side	0	0%
Upward House Side	0	0%
Upward Total	0	0%
Total Flux	7885	100%

ISOFOOT CANDLE PLOT

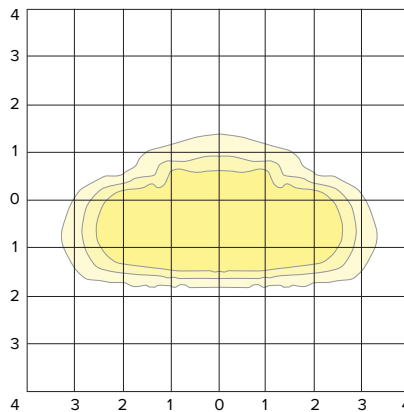

WDS-D-24L-75-4K7-3

LUMINAIRE DATA

Description	4000K, 70CRI
Delivered Lumens	7858
Watts	74
Efficacy	106.2
IES Type	III
BUG Rating	B1-U0-G2
Mounting Height	15 ft
Grid Scale	15 ft

ZONAL LUMEN SUMMARY

Zone	Lumens	% Luminaire
Downward Street Side	6551	83.4%
Downward House Side	1307	16.6%
Downward Total	7858	100%
Upward Street Side	0	0%
Upward House Side	0	0%
Upward Total	0	0%
Total Flux	7858	100%

ISOFOOT CANDLE PLOT

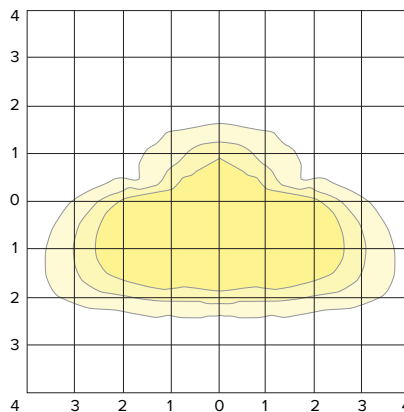

WDS

WALL MOUNTED

PHOTOMETRY

WDS-D-24L-75-4K7-4F

LUMINAIRE DATA

Description	4000K, 70CRI
Delivered Lumens	7865
Watts	74
Efficacy	106.3
IES Type	III
BUG Rating	B1-U0-G2
Mounting Height	15 ft
Grid Scale	15 ft

ZONAL LUMEN SUMMARY

Zone	Lumens	% Luminaire
Downward Street Side	6782	86.2%
Downward House Side	1083	13.8%
Downward Total	7865	100%
Upward Street Side	0	0%
Upward House Side	0	0%
Upward Total	0	0%
Total Flux	7865	100%

ISOFOOT CANDLE PLOT

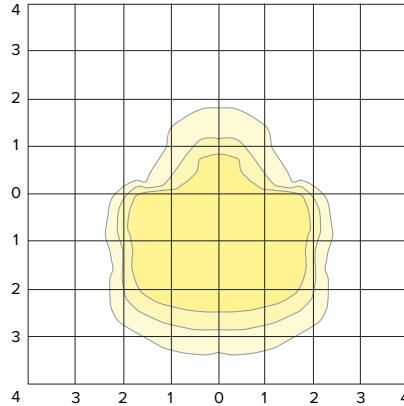

WDS-D-24L-75-4K7-4W

LUMINAIRE DATA

Description	4000K, 70CRI
Delivered Lumens	7685
Watts	74
Efficacy	103.9
IES Type	III
BUG Rating	B1-U0-G2
Mounting Height	15 ft
Grid Scale	15 ft

ZONAL LUMEN SUMMARY

Zone	Lumens	% Luminaire
Downward Street Side	6794	88.4%
Downward House Side	892	11.6%
Downward Total	7685	100%
Upward Street Side	0	0%
Upward House Side	0	0%
Upward Total	0	0%
Total Flux	7685	100%

ISOFOOT CANDLE PLOT

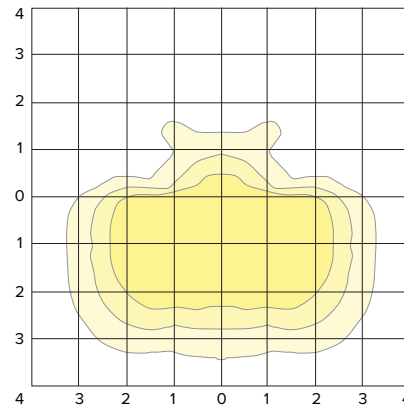

WDS-D-24L-75-4K7-FTD

LUMINAIRE DATA

Description	4000K, 70CRI
Delivered Lumens	6717
Watts	74
Efficacy	90.8
IES Type	III
BUG Rating	B2-U0-G1
Mounting Height	15 ft
Grid Scale	15 ft

ZONAL LUMEN SUMMARY

Zone	Lumens	% Luminaire
Downward Street Side	4462	66.4%
Downward House Side	2255	33.6%
Downward Total	6717	100%
Upward Street Side	0	0%
Upward House Side	0	0%
Upward Total	0	0%
Total Flux	6717	100%

ISOFOOT CANDLE PLOT

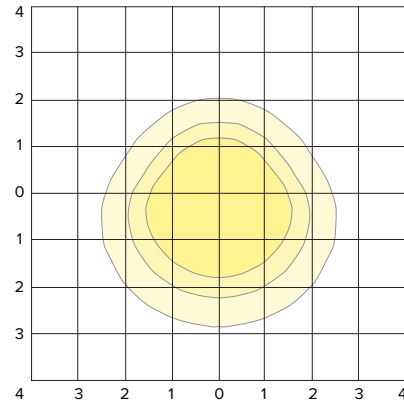

WDS

WALL MOUNTED

PHOTOMETRY

WDS-D-24L-75-4K7-SP

LUMINAIRE DATA

Description	4000K, 70CRI
Delivered Lumens	8471
Watts	74
Efficacy	114.5
IES Type	VS
BUG Rating	B4-U0-G0
Mounting Height	15 ft
Grid Scale	15 ft

ZONAL LUMEN SUMMARY

Zone	Lumens	% Luminaire
Downward Street Side	4236	50.0%
Downward House Side	4236	50.0%
Downward Total	8471	100%
Upward Street Side	0	0%
Upward House Side	0	0%
Upward Total	0	0%
Total Flux	8471	100%

ISOFOOT CANDLE PLOT

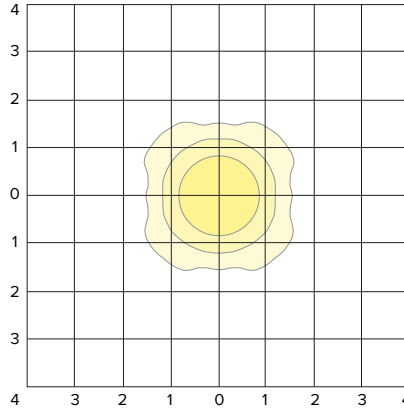

WDS-D-24L-75-4K7-WG

LUMINAIRE DATA

Description	4000K, 70CRI
Delivered Lumens	7396
Watts	74
Efficacy	99.9
IES Type	I
BUG Rating	B3-U0-G1
Mounting Height	15 ft
Grid Scale	15 ft

ZONAL LUMEN SUMMARY

Zone	Lumens	% Luminaire
Downward Street Side	4931	66.7%
Downward House Side	2465	33.3%
Downward Total	7396	100%
Upward Street Side	0	0%
Upward House Side	0	0%
Upward Total	0	0%
Total Flux	7396	100%

ISOFOOT CANDLE PLOT

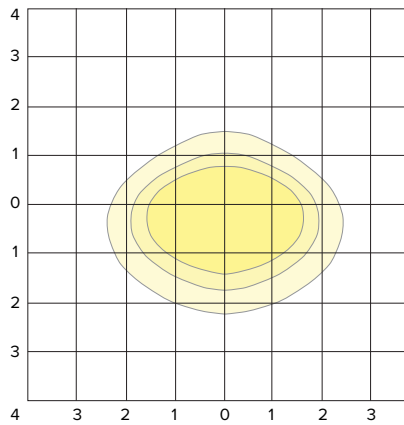

WDS-D-24L-75-4K7-WTD

LUMINAIRE DATA

Description	4000K, 70CRI
Delivered Lumens	7413
Watts	74
Efficacy	100.2
IES Type	I
BUG Rating	B2-U0-G1
Mounting Height	15 ft
Grid Scale	15 ft

ZONAL LUMEN SUMMARY

Zone	Lumens	% Luminaire
Downward Street Side	5341	72.1%
Downward House Side	2072	27.9%
Downward Total	7413	100%
Upward Street Side	0	0%
Upward House Side	0	0%
Upward Total	0	0%
Total Flux	7413	100%

ISOFOOT CANDLE PLOT

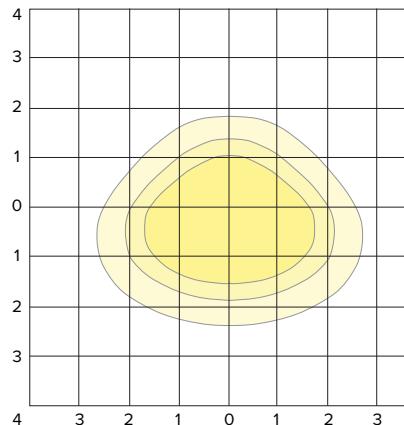

TM-30 DATA

COLOR VECTOR GRAPHIC

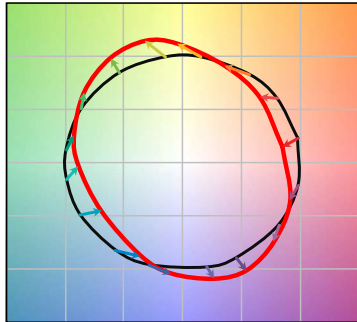

— Reference Illuminant — Test Source

TEST SOURCE

R _f	68
R _a	99
CCT(K)	3947
D _{uv}	0.0004
x	0.3831
y	0.3793
CIE R _a	72

SPECTRAL POWER DISTRIBUTION COMPARISON

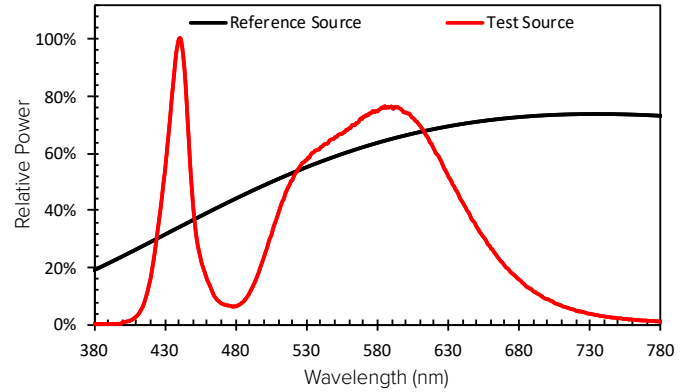

ELECTRICAL DATA

Drive Current	System Watts	Line Voltage		Amps AC						Min. Power Factor	Max THD (%)	Dimming Range	Dimming			
		VAC	Hz	120	208	240	277	347	480				Source current out of 0-10V		Absolute voltage range on 0-10V (+)	
													Min	Max	Min	Max
350mA	29	120-480	50/60	0.24	0.14	0.12	0.10	0.08	0.06	>0.9	20	10% to 100%	0mA	1mA	0V	10V
500mA	42			0.38	0.22	0.19	0.16	0.13	0.09							
725mA	59			0.48	0.27	0.24	0.21	0.16	0.12							
925mA	74			0.67	0.39	0.34	0.29	0.23	0.17							

TM-21 Lifetime Calculation - Projected Lumen Maintenance (25°C / 77°C)						
Ambient Temp.	0	25,000	36,000	50,000	100,000	Reported L70
25°C / 77°F	100%	97%	95%	93%	86%	60khrs
40°C / 104°F	100%	92%	89%	86%	75%	

CRI Lumen Multiplier			
CCT	70 CRI	80 CRI	90 CRI
3000K	1	0.9119	0.7033
4000K	1	0.8941	0.734
5000K	1	0.879	0.7712

Amber Multiplier	
CCT	Multiplier
5000K	1
AM	0.1727

2700K Multiplier	
CCT	Multiplier
5000K	1
2700K	0.897