

Revisions

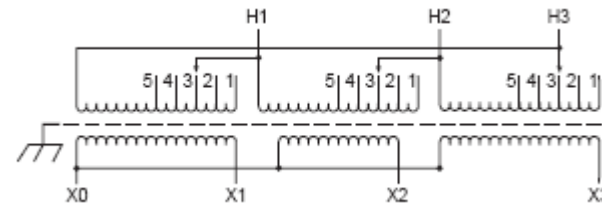
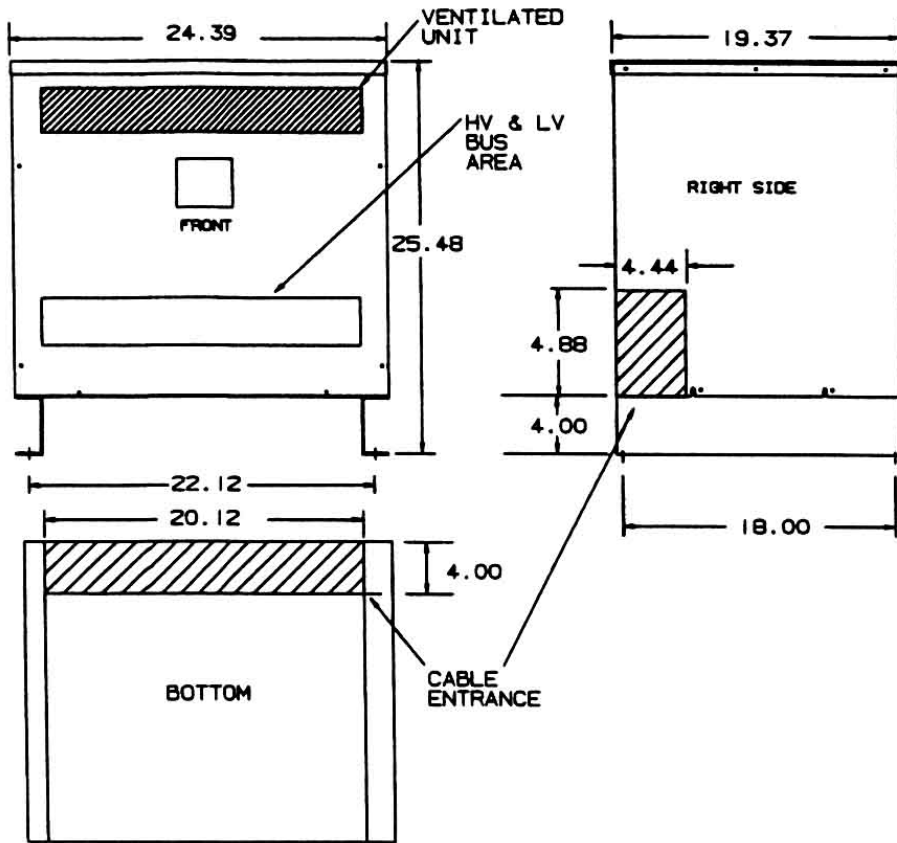

Primary Volts	%	Connect Leads to Tap No.
604	105	1
589	102.5	2
575	100	3
561	97.5	4
546	95	5
Secondary Volts		
230		X1, X2, X3
133		X1 & X0
1 phase		X2 & X0
		X3 & X0

NOTE: PRIMARY AND SECONDARY BUS AREA IN FRONT OF CASE.

KEY: DENOTES CONDUIT AREAS

KVA	CATALOG NUMBER	VOLTAGE		WEATHER SHIELD	WEIGHT	PHASE	FREQ.
		HIGH	LOW				
40	DTHA-040-4S	575Δ	230Y/133	WS-A-1	395 Lbs	3φ	60 Hz

Winding Rise:	150°C
Insulation:	220°C
Sound Level:	45db

TYPICAL PERFORMANCE DATA

Regulation @ 100% PF:	
Standards:	UL/CSA

Windings:	AL
Impedance:	

Typical Efficiency:	
No Load Losses:	
Full Load Losses:	

Type No.

DRAWN:

DATE: August 27, 2015

CASE

Control
7

A

1