

TRANSFORMER SPECIFICATIONS	
PRIMARY VOLTAGE(S)	230/460/575
SECONDARY VOLTAGE(S)	95/115
RATED V.A.	350
RATED FREQUENCY	50/60
INSULATION CLASS	130°C @ MAX. RISE 80°C
AGENCY APPROVALS	UL, CUL
ESTIMATED WEIGHT	13.6 LBS

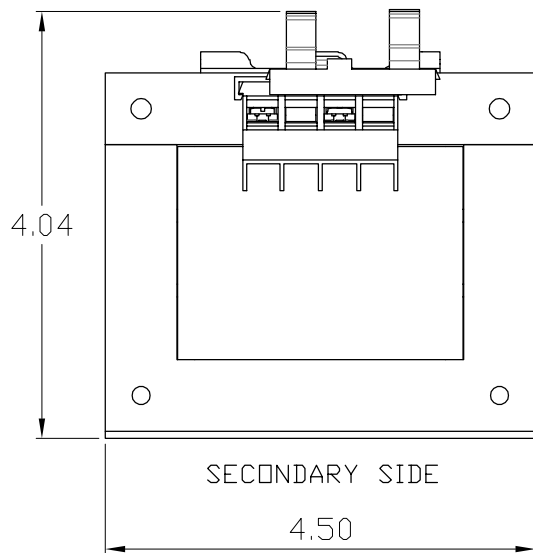

SECONDARY SIDE PRIMARY SIDE

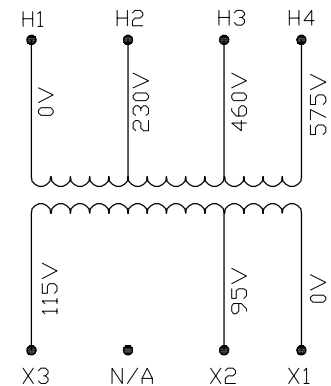
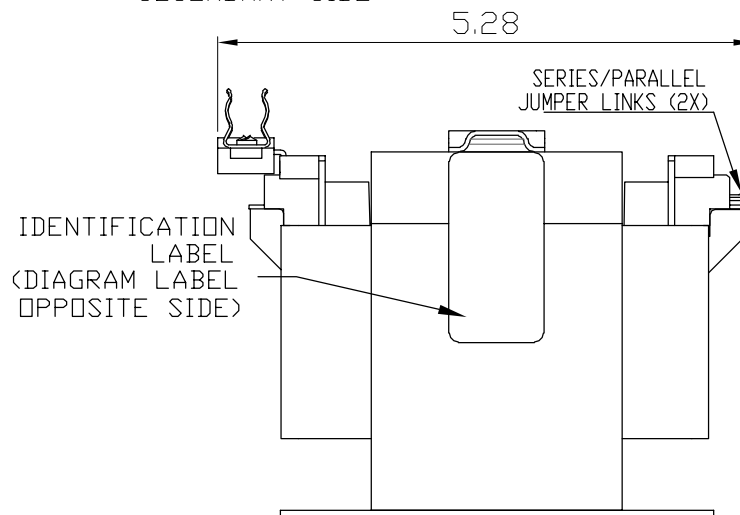

CONNECTION DIAGRAM

DIMENSIONS ARE IN INCHES TOLERANCES: .XX ± .03 .XXX ± .010 ANGULAR: ± 1°	NAME	DATE
	DRAWN BY: VS	05/13/2020
SOURCE N/A	CHECKED BY:	
MATERIAL N/A	PROPRIETARY AND CONFIDENTIAL	
FINISH N/A	THE INFORMATION CONTAINED IN THIS DRAWING IS THE SOLE PROPERTY OF ACME. ANY REPRODUCTION IN PART OR AS A WHOLE WITHOUT THE WRITTEN PERMISSION OF ACME IS PROHIBITED.	
DO NOT SCALE DRAWING		



DESCRIPTION:	
350 VA	
SIZE	DWG. NO.
A	TB350N011F0